

Superb Finishing



superb finishing



All technical details on this leaflet are information purposes only and are subject to change without prior notice.



P SMART AIR DISC VALVES

- Mounting in 1 minute: Intellectual design enabling easy and quick mounting on the wall and ceiling
- Energy Saver: Optimum aerodynamic design ensuring very low pressure loss for supply and exhaust
- Recyclable: it is made from ABS plastic entirely
- Aesthetic compatibility with indoor ambience.
- Resistant to external impacts and having aesthetic appearance
- Contributing to have better indoor air quality and highly efficient in use. Integrated design eliminating air leakages

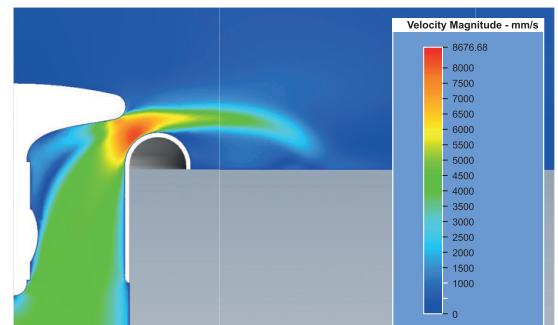
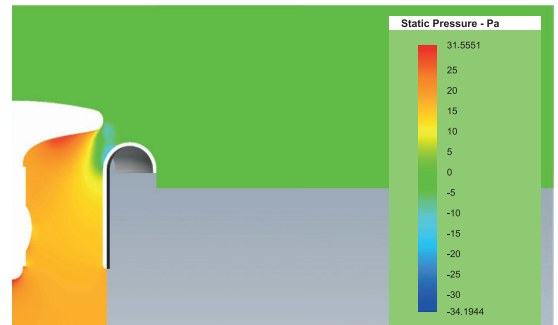
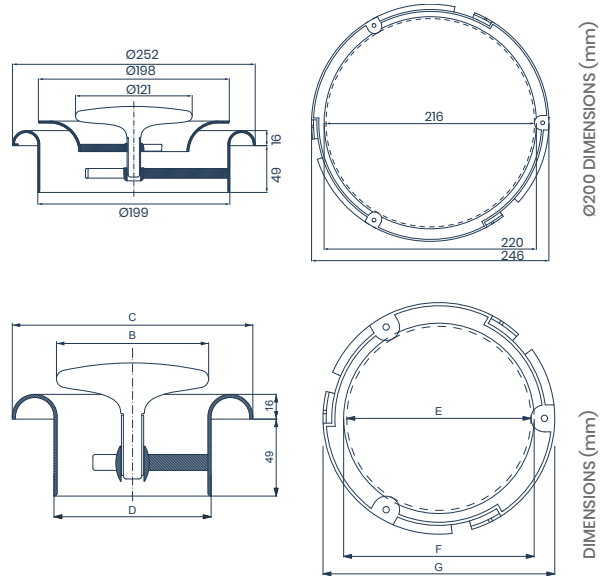

		DIMENSIONS					
NOMINAL SIZE		Ø B	Ø C	Ø D	Ø E	Ø F	Ø G
P SMART	Ø 100	96	152	99	116	120	146
	Ø 125	121	177	124	141	145	171
	Ø 150	146	202	149	166	170	196
	Ø 200	121	252	199	216	220	246



P-SMART

Innovative design
for exhaust & supply

Whole plastic screw
no metal part no corrosion

No deviation in air flow
constant air flow

Smart montage ring

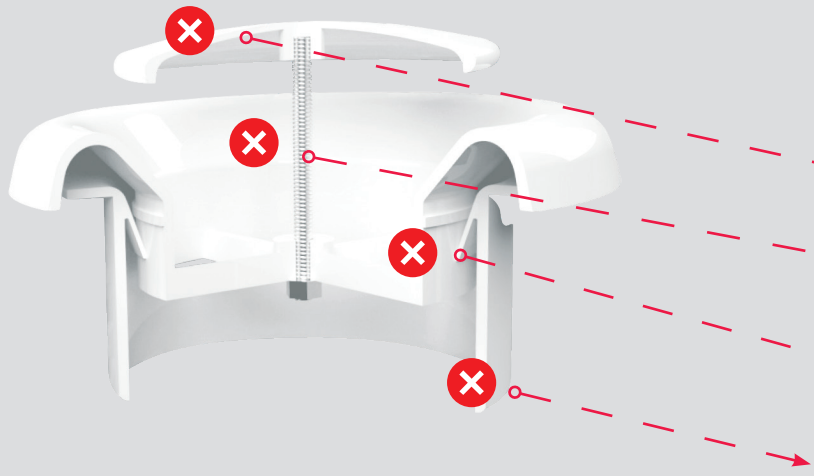

TRADITIONAL

Traditional design
for exhaust & supply

Metal screw
corrosion danger

Deviation in air flow

Traditional montage methods

MONTAGE:

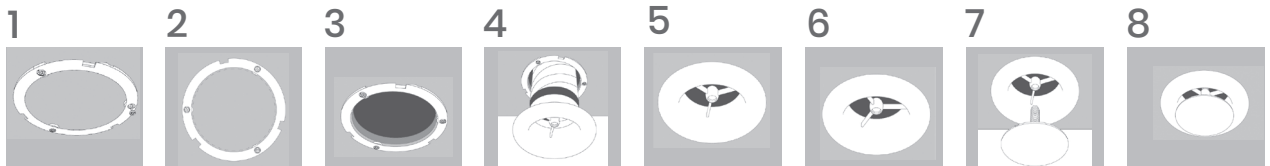

1
Screw the mounting ring where product needs to be mounted

2
Use the fins on mounting ring as a template for punching a hole.

3
Punch the hole by assistance of the template

4
Connect the duct onto collar of flanged diffuser.

5
Place the fixture elements behind flanged diffuser where the gaps on the ring coincide with.

6
Turn the flanged diffuser clock-wise to secure locking.

7
Screw the lid onto threaded hole at the middle of flanged diffuser.

8
Rotate the lid to adjust air flow rate.



superb finishing



Versatile Smart Series **L SMART** LINEAR GRILLS

- Exchangeable collars
- Aesthetic new design
- Excellent design for both supply and exhaust ventilation
- Easy and practical montage to both walls and ducts
- Manufactured from ABS plastic
- Easy maintenance
- Mosquito net standard

MODEL	NOMINAL SIZE	Ø D
CONAIR 1040	No Collar	No Collar
CONAIR 1041	Ø 100	Ø 99
CONAIR 1042	Ø 125	Ø 124
CONAIR 1043	Ø 150	Ø 149

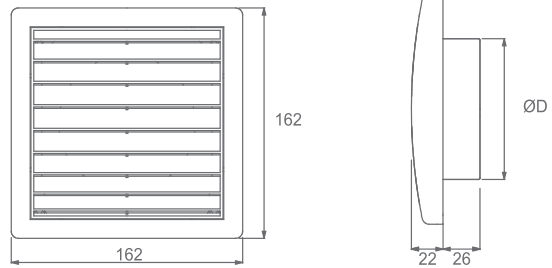

DIMENSIONS (mm)

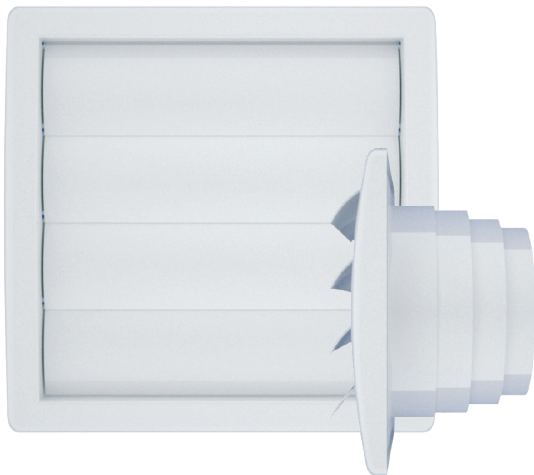

GRAVITY LOUVERS WITH 4 SET COLLAR

- Excellent design for exhaust ventilation
- For outside use, for movement of air one way from inside to outside
- Louvres balanced to give good air flow at appropriate pressure level
- Convenient for 4 size diameter usage
- Easy and practical montage
- Easy maintenance

MODEL	NOMINAL SIZE	DESCRIPTION	Ø D
CONAIR 025	Ø 100	Gravity louver with 4 set collar	Ø 98mm
	Ø 110		Ø 108mm
	Ø 120		Ø 118mm
	Ø 125		Ø 123mm

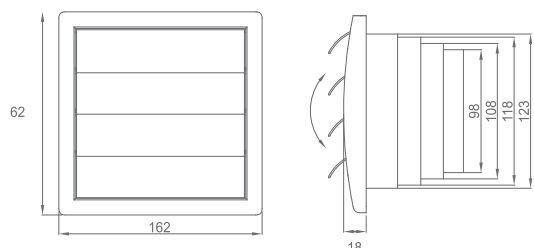

DIMENSIONS (mm)



Versatile Smart Series **G SMART** GRAVITY LOUVERS

- Exchangeable collars
- Aesthetic new design
- Excellent design for exhaust ventilation
- Easy and practical montage to both walls and ducts
- Manufactured from ABS plastic
- Easy maintenance
- Louvres balanced to give good air flow at appropriate pressure level
- One way air flow from indoors towards outdoors
- Mosquito net standard (except conair 1044)

MODEL	NOMINAL SIZE	Ø D
CONAIR 1044	No Collar	No Collar
CONAIR 1045	Ø 100	Ø 99
CONAIR 1046	Ø 125	Ø 124
CONAIR 1047	Ø 150	Ø 149

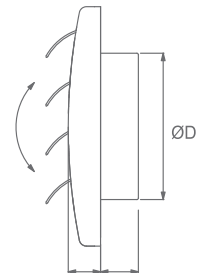
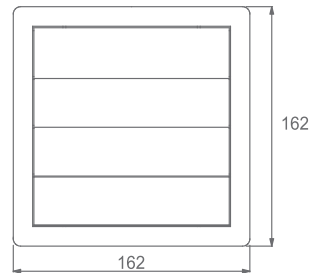

DIMENSIONS (mm)



Versatile Smart Series **C SMART** COWL OUTLET

- Exchangeable collars
- Aesthetic new design
- Excellent design for both supply and exhaust ventilation
- Easy and practical montage to both walls and ducts
- Manufactured from ABS plastic
- Easy maintenance
- For outdoors suitable for tumble drier extraction
- Mosquito net standard

MODEL	NOMINAL SIZE	Ø D
CONAIR 1048	No Collar	No Collar
CONAIR 1049	Ø 100	Ø 99
CONAIR 1050	Ø 125	Ø 124
CONAIR 1051	Ø 150	Ø 149

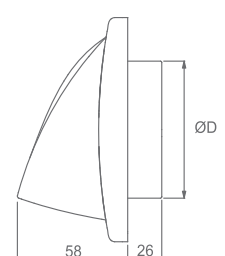
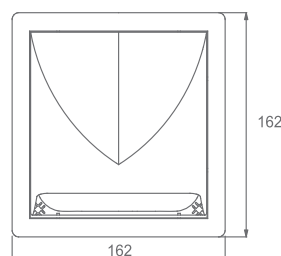

DIMENSIONS (mm)

superb finishing

ROUND DUCTING CONNECTOR WITH BACK DRAUGHT SHUTTER



- Ideal for domestic and light commercial applications
- Plastic Back Draught shutter to prevent outside air from passing through the unit in reverse direction when the fan is not operating

MODEL	DESCRIPTION	NOMINAL DIAMETER (mm)
CONAIR 061	Plastic Backdraught Shutter	125

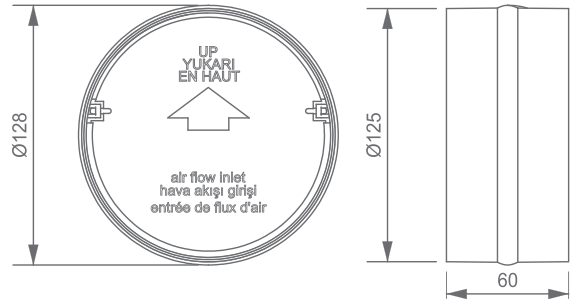

DIMENSIONS (mm)

CEILING DIFFUSER



- Economical high performance diffuser
- Providing on architecturally pleasing ceiling affect
- Excellent design for surface mounting applications
- Multilayer cone can divide the air into many layers of swift puffs
- Smoothly balances the flow and temperature of the air
- Manufactured from ABS plastic
- Easy and practical montage
- Easy maintenance
- Mosquito net standard

MODEL		DIMENSIONS			
		NOMINAL SIZE	Ø A	Ø B	Ø C
CONAIR 031		Ø 100	Ø 100	141	70
CONAIR 032		Ø 125	Ø 124	166	71
CONAIR 033		Ø 150	Ø 150	188	73

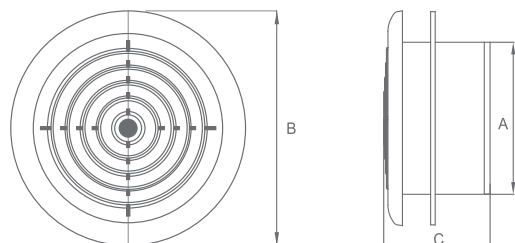

DIMENSIONS (mm)

ROUND LINEAR GRILLS



- Innovative design for exhaust and supply ventilation
- Convenient for connecting to round duct
- Adjustable collar diameter (only conair 008)
- Convenient for wall application
- Easy and practical montage
- Round frame
- Easy maintenance
- Various color options
- Mosquito net standard (only conair 008)

MODEL	NOMINAL SIZE	DESCRIPTION	Ø D
CONAIR 006	Ø 100	Round linear grill	Ø 103
CONAIR 007	Ø 200	Round linear grill	Ø 199
CONAIR 008	Ø 100-150	Round linear grills adjustable collar	Ø 103-153

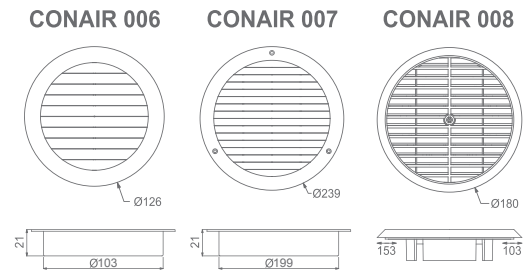

DIMENSIONS (mm)

DOOR TRANSFER GRILLS

- Allows air circulations
- Double sided
- Overlapping V-shaped blades
- For mounting on doors in WC areas, showers, swimming pools etc.
- Various color options on demand
- Both parts of the grill are joined together by screws
- Easy and practical montage
- Easy maintenance



MODEL	DESCRIPTION	DIMENSIONS(mm)
CONAIR 019	Door Transfer Grill	300 X 80
CONAIR 020	Door Transfer Grill	404 X 90

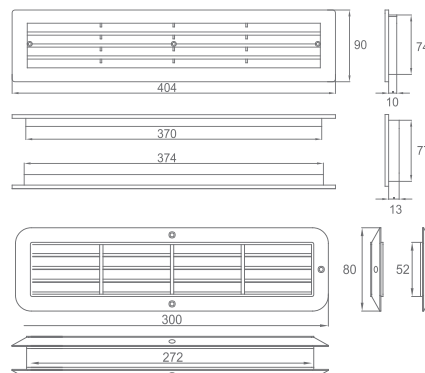

DIMENSIONS (mm)

Superb Finishing



AFS[®]

FLEXIBLE KANAL AŞ

İvedik OSB 1468. Cad. No: 153
06370 Yenimahalle ANKARA/TÜRKİYE
T: +90 312 395 48 60
F: +90 312 395 48 68

afs.com.tr

   [afsflex](https://www.facebook.com/afsflex)

