

  
**elbimed**



**Surgical Drape Sets**



ELBIMED ALL AROUND THE WORLD

Driven by the expertise and experience of Elbi Pharma, Elbimed is becoming a preferred brand in Türkiye and worldwide.

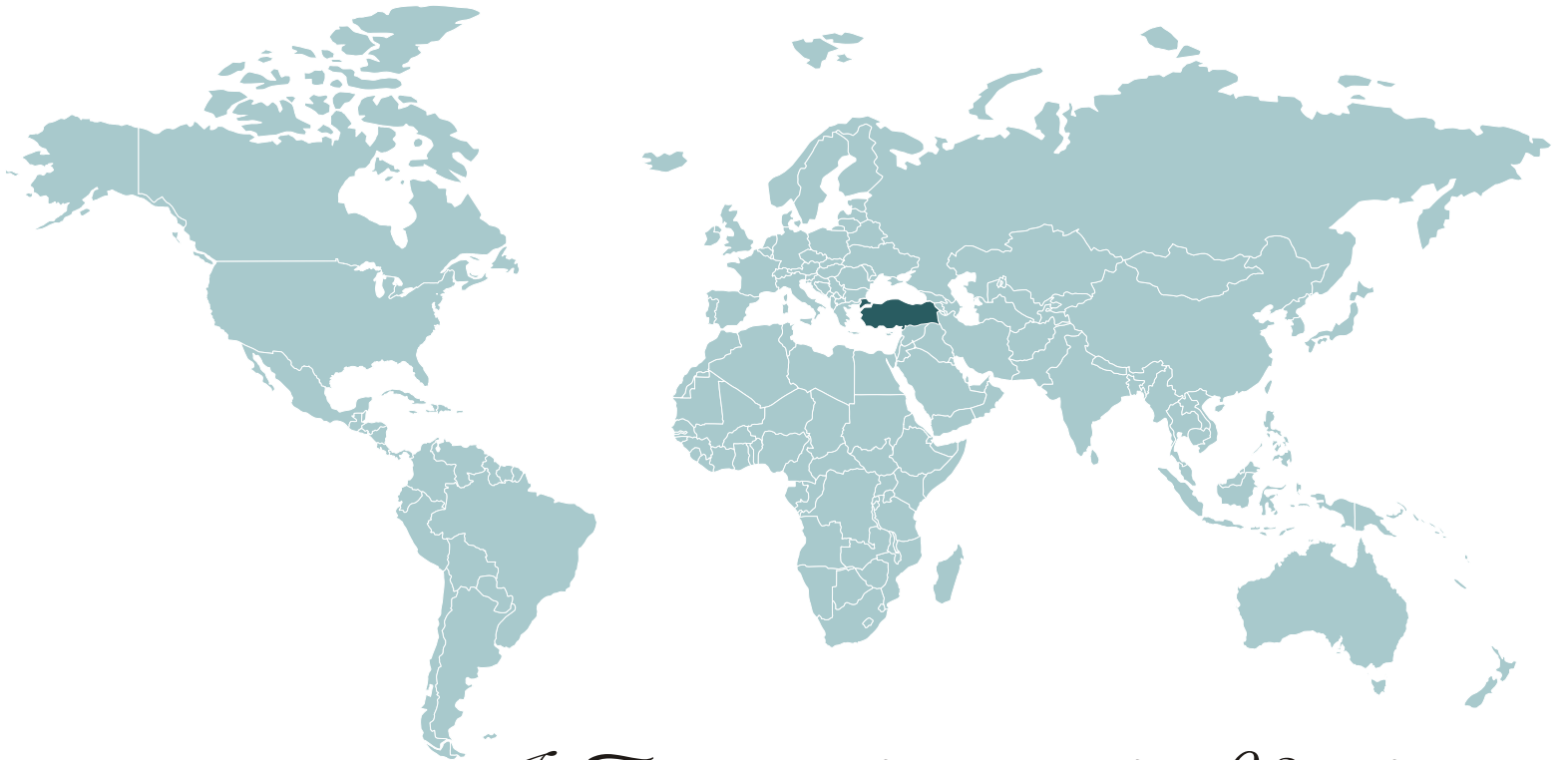

*In Türkiye and all around the World...*

# Our purpose is to provide efficient, safe, practical, and sterile solutions for surgical processes.

Established in 1980, Elbi Pharma has become a trusted name within the global healthcare sector. Shaped by the expertise and experience of Elbi Pharma, Elbimed continues this strong legacy with a broader vision through its range of sterile, disposable surgical drape sets and medical product groups.

All our product lines are developed with a deep understanding of the needs of different surgical specialties, offering practical and diversified solutions tailored to specific clinical applications. What strengthens Elbimed today is its commitment to high-quality production, reliable service standards, and a precise understanding of healthcare professionals' expectations ensuring that we deliver the most suitable solutions.

We hope that our products will contribute to clinical processes and that we will always be with you as a reliable partner in the field of healthcare.

**Nejla ÇAKMAK**  
CEO





## CONTENTS

ELB2001	GENERAL SURGERY DRAPE SET .....	07
ELB2002	BY-PASS DRAPE SET .....	08
ELB2003	VALVE REPLACEMENT DRAPE SET .....	09
ELB2004	CARDIOVASCULAR DRAPE SET .....	10
ELB2005	ANGIOGRAPHY DRAPE SET .....	11
ELB2006	MATERNITY DRAPE SET .....	13
ELB2007	CESAREAN DRAPE SET .....	14
ELB2008	OVUM PICK UP DRAPE SET .....	15
ELB2009	IN VITRO FERTILIZATION DRAPE SET .....	16
ELB2010	EXTREMITY DRAPE SET .....	18
ELB2011	KNEE DRAPE SET .....	19
ELB2012	SHOULDER DRAPE SET .....	20
ELB2013	ARTHROPLASTY (HIP) DRAPE SET .....	21
ELB2014	VERTEBRA DRAPE SET .....	22
ELB2015	ARTHROSCOPY DRAPE SET .....	23
ELB2016	HAND SURGERY DRAPE SET .....	24
ELB2017	MINOR SURGERY DRAPE SET .....	25
ELB2018	CRANIOTOMY DRAPE SET .....	26
ELB2019	SHUNT DRAPE SET .....	27
ELB2020	E.N.T. (EAR NOSE THROAT) DRAPE SET .....	28
ELB2021	EYE DRAPE WITH POUCH .....	29
ELB2021-2	EYE DRAPE WITH POUCH .....	29
ELB2022	EYE DRAPE WITH DOUBLE POUCH .....	29
ELB2022-2	EYE DRAPE WITH DOUBLE POUCH .....	29
ELB2023	EYE DRAPE SET .....	30
ELB2024	RHINOPLASTY DRAPE SET .....	31
ELB2025	DENTAL DRAPE SET .....	32
ELB2026	IMPLANT DRAPE SET .....	33
ELB2027	ABDOMINAL DRAPE SET .....	35
ELB2028	LAPAROTOMY DRAPE SET .....	36
ELB2029	LAPAROSCOPY DRAPE SET .....	37
ELB2030	PERCUTANEOUS DRAPE SET .....	38
ELB2031	TRANSURETHRAL RESECTION DRAPE SET .....	39
ELB2032	CYSTOSCOPY DRAPE SET .....	40
ELB2033	CHEMOTHERAPY DRAPE SET .....	41
ELB2034	BIOPSY (TESE) DRAPE SET .....	42
ELB2035	DRESSING DRAPE SET .....	43
ELB2036	HAIR DRAPE SET .....	43
	PERSONAL PROTECTIVE EQUIPMENTS .....	44



Our extensive product portfolio, designed to meet the specific requirements of various surgical disciplines, provides healthcare professionals with full protection at critical moments.

# General Surgery Drape Set

CONTENT	SIZE	QUANTITY
Anesthesia Drape	150 x 240 cm	1
Foot Drape	150 x 180 cm	1
Drape With Adhesive Tape	75 x 100 cm	2
Back Table Cover	150 x 200 cm	1
Mayo Stand Cover	80 x 150 cm	1
Reinforced Surgical Gown	Large	2
Towel	40 x 40 cm	2
Op-tape	10 x 30 cm	2
Sponge	10 x 10 cm	5
Cotton Balls	3 cm	10
Forceps		3
Tray		1
Kidney Tray		1
Sterilization Wrap	100 x 100 cm	1

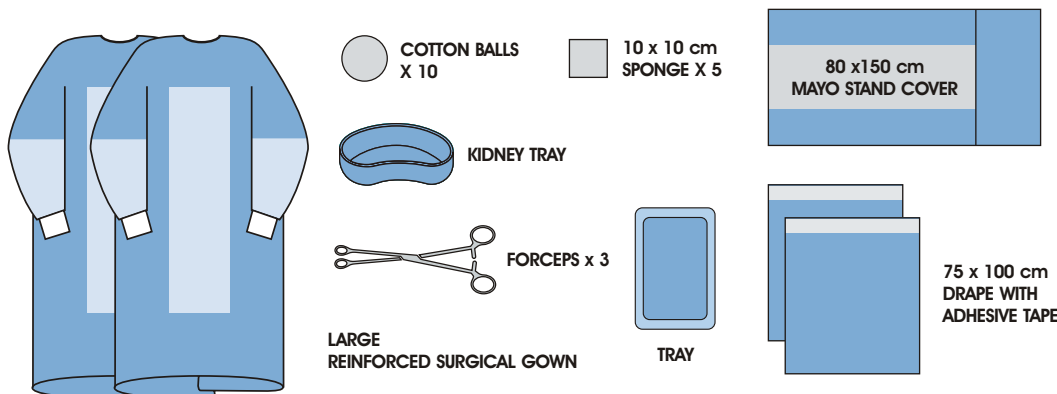
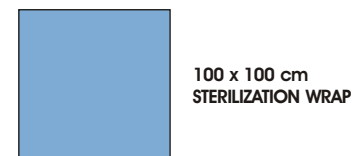
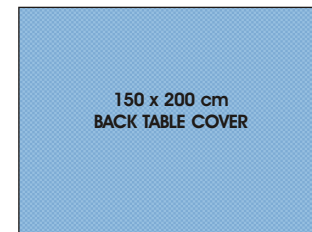
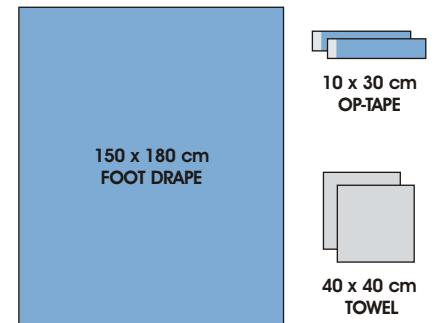

## By-Pass Drape Set

CONTENT	SIZE	QUANTITY
Cardiovascular Drape	240 x 350 cm	1
"U" Split Perineum Drape	150 x 240 cm	1
Foot Cover	60 x 110 cm	2
Back Table Cover	150 x 200 cm	1
Mayo Stand Cover	80 x 150 cm	1
Reinforced Surgical Gown	L	2
Reinforced Surgical Gown	M	1
Towel	40 x 40 cm	5
Op-tape	10 x 30 cm	2
Stockinettes	40 x 80 cm	2
Waste Bag	30 x 35 cm	2
Sterilization Wrap	100 x 100 cm	1

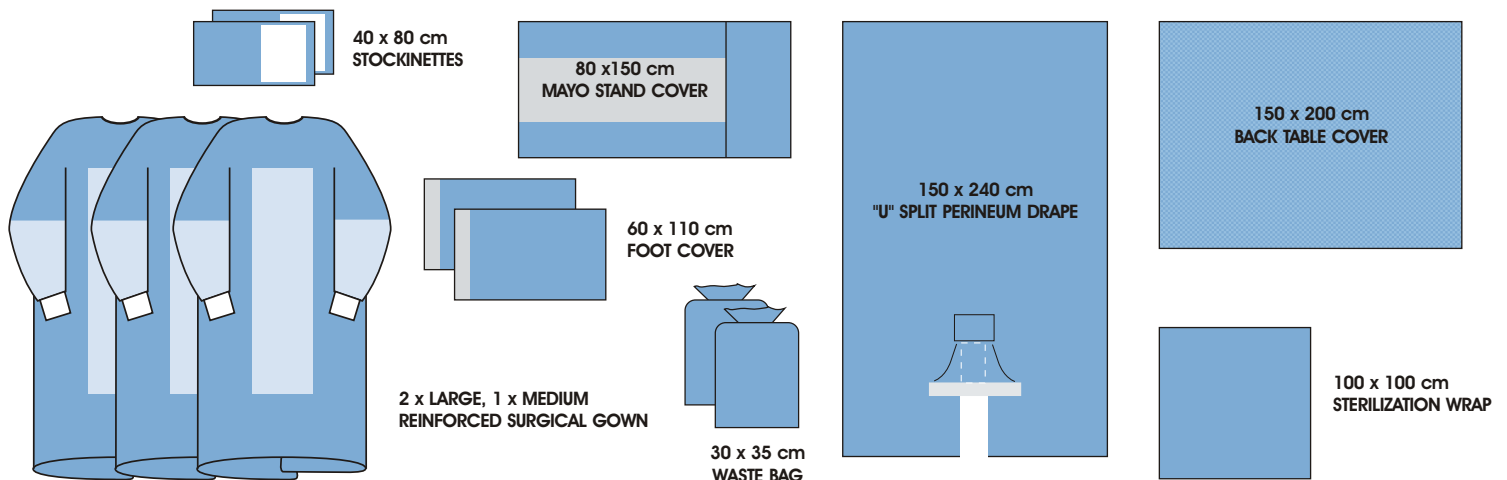
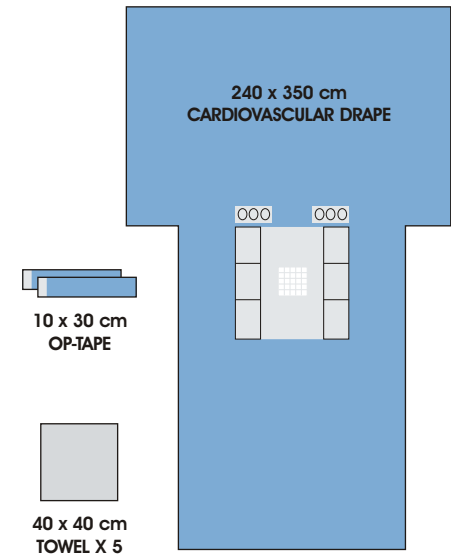

## Valve Replacement Drape Set

CONTENT	SIZE	QUANTITY
Cardiovascular Drape	240 x 350 cm	1
Back Table Cover	150 x 200 cm	1
Mayo Stand Cover	80 x 150 cm	1
Reinforced Surgical Gown	Large	3
Towel	40 x 40 cm	2
Op-tape	10 x 30 cm	2
Waste Bag	30 x 35 cm	2
Sterilization Wrap	100 x 100 cm	1

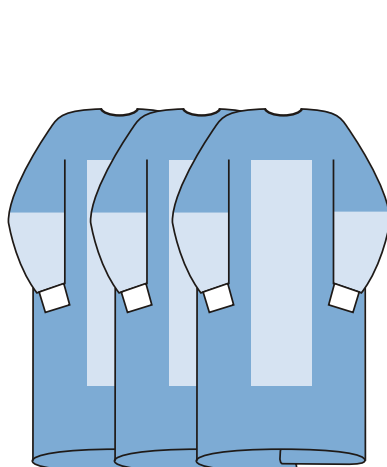
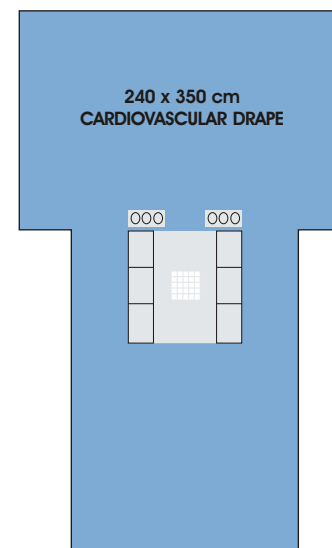

10 x 30 cm  
OP-TAPE



40 x 40 cm  
TOWEL



30 x 35 cm  
WASTE BAG

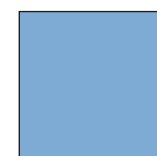

100 x 100 cm  
STERILIZATION WRAP

## Cardiovascular Drape Set

CONTENT	SIZE	QUANTITY
Drape With Adhesive Tape	70 x 100 cm	2
Drape With Adhesive Tape	100 x 100 cm	1
Drape With Adhesive Tape	200 x 150 cm	1
Back Table Cover	150 x 200 cm	1
Mayo Stand Cover	80 x 150 cm	1
Reinforced Surgical Gown	Large	3
Towel	40 x 40 cm	2
Sterilization Wrap	100 x 100 cm	1

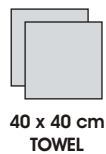
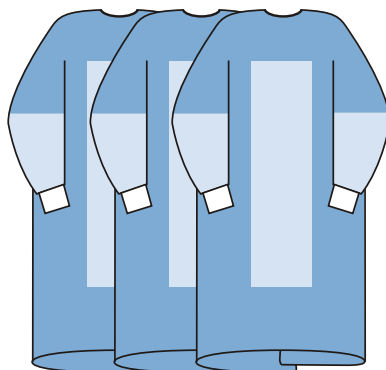
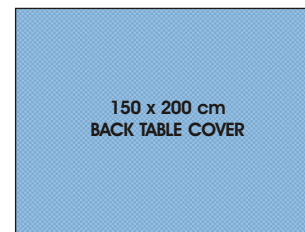
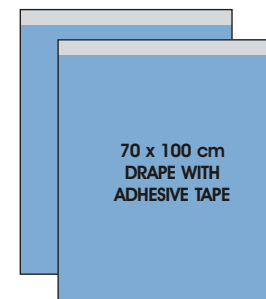
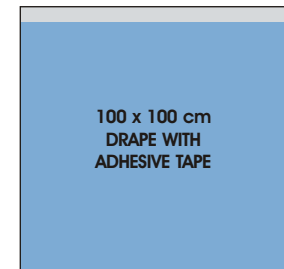
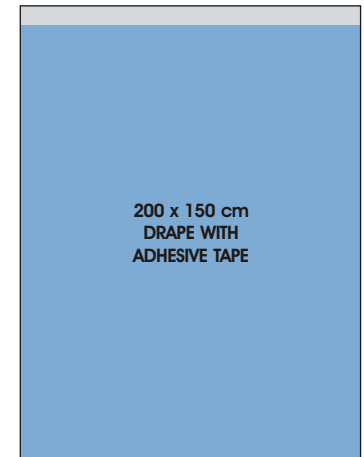

# Angiography Drape Set

CONTENT	SIZE	QUANTITY
Angiography Drape	150 x 250 cm	1
Back Table Cover	150 x 200 cm	1
Standard Surgical Gown	Large	2
Towel	40 x 40 cm	2
Sponge	7,5 x 7,5 cm	10
Solution Bowl	500 cc	1
Fluoroscopy Cover	85 x 85 cm	1
Betadine Sponge		1
Tray		1
Sterilization Wrap	100 x 100 cm	1

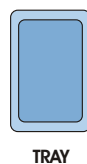
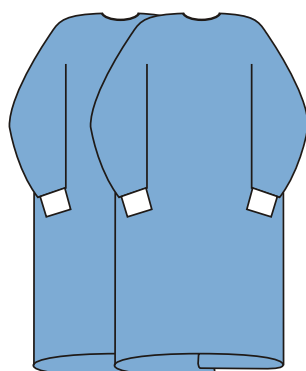
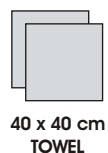
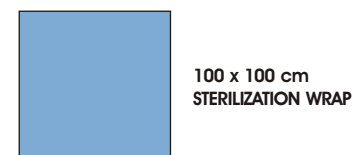
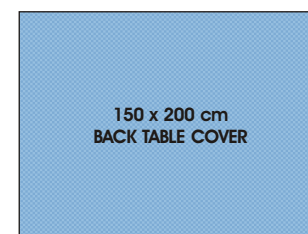
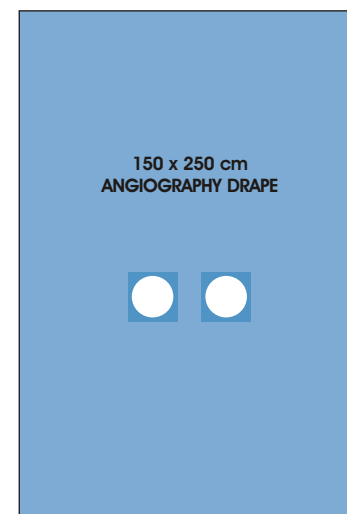

## **ELBIMED's quality standards frame:**

- High liquid-barrier nonwoven materials,
- Microbial-resistant structural designs,
- Low-particle-release technologies,
- Time-saving ergonomic folding



# Maternity Drape Set



CONTENT	SIZE	QUANTITY
Drape With Adhesive Tape	75 x 150 cm	1
Baby Drape	75 x 75 cm	1
Drape	75 x 100 cm	1
Leg Cover	50 x 100 cm	2
Back Table Cover	150 x 200 cm	1
Reinforced Surgical Gown	Large	2
Towel	40 x 40 cm	2
Umbilical Cord Clamp		1
Mother - Baby Armband	Pink & Blue	2
Waste Bag	50 x 60 cm	1
Sterilization Wrap	100 x 100 cm	1

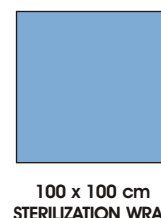
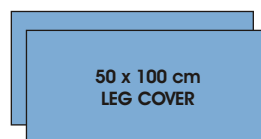
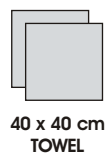
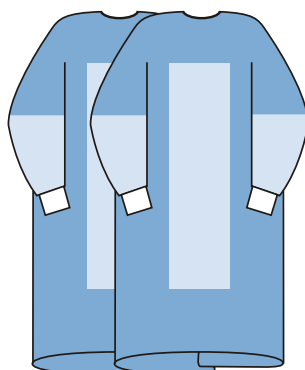
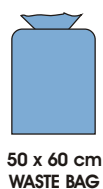
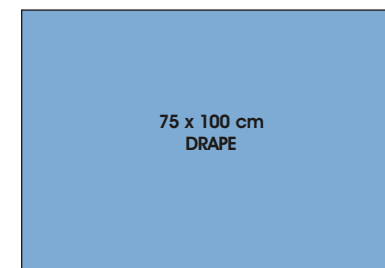

# Cesarean Drape Set



CONTENT	SIZE	QUANTITY
Cesarean Drape	200 x 300 cm	1
Baby Drape	75 x 75 cm	1
Drape	75 x 100 cm	1
Back Table Cover	150 x 200 cm	1
Reinforced Surgical Gown	Large	2
Towel	40 x 40 cm	2
Umbilical Cord Clamp		1
Mother - Baby Armband	Pink & Blue	2
Waste Bag	50 x 60 cm	1
Sterilization Wrap	100 x 100 cm	1

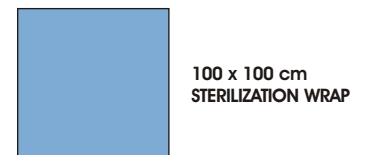
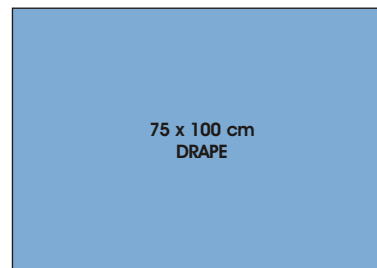
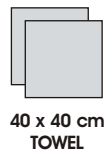
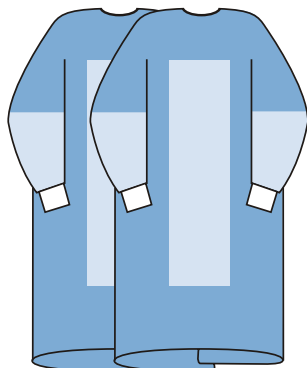
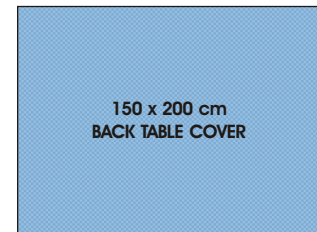
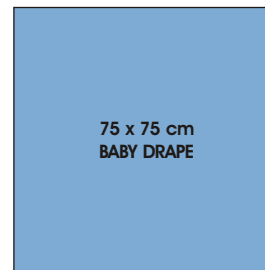
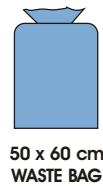
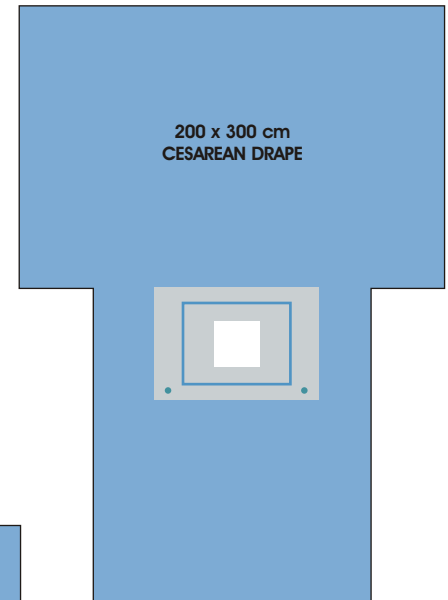

## Ovum Pick Up Drape Set

CONTENT	SIZE	QUANTITY
Ovum Pick Up Drape	130 x 150 cm	1
Drape	75 x 100 cm	1
Transparent Drape	60 x 60 cm	1
Leg Cover	50 x 100 cm	2
Back Table Cover	150 x 200 cm	1
Standard Surgical Gown	Large	2
Towel	40 x 40 cm	2
Sterilization Wrap	100 x 100 cm	1

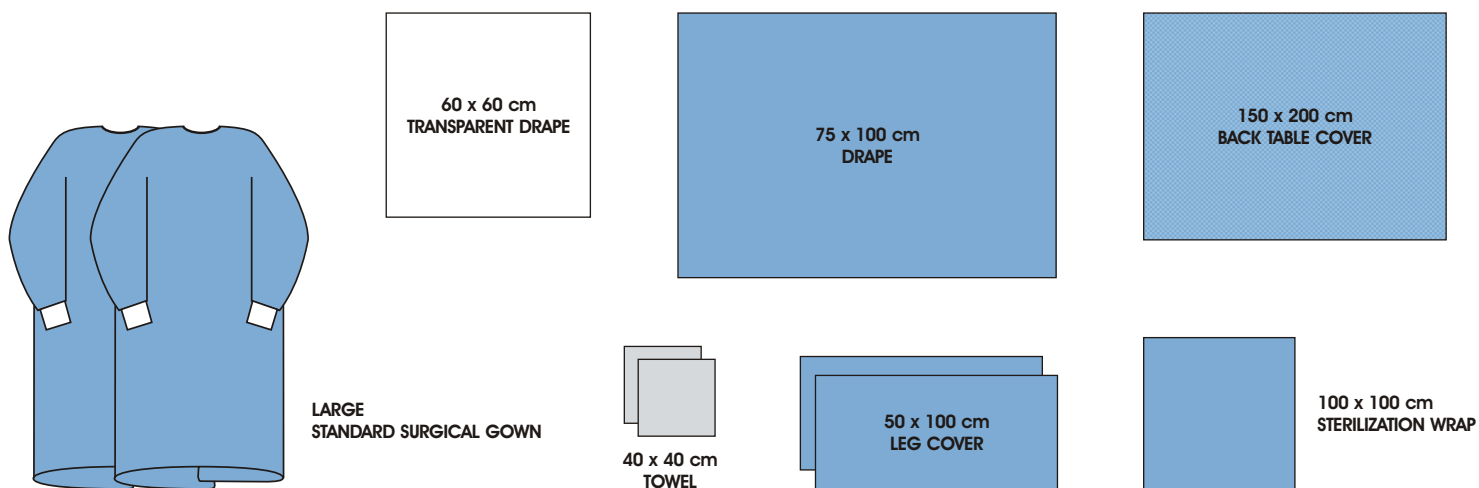
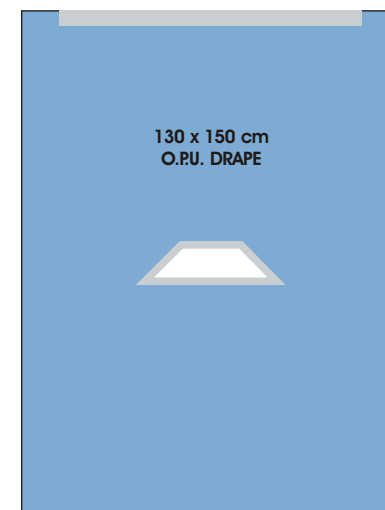

## In Vitro Fertilization Drape Set

CONTENT	SIZE	QUANTITY
I.V.F. Drape	150 x 225 cm	1
Leg Cover	50 x 100 cm	2
Back Table Cover	150 x 200 cm	1
Standard Surgical Gown	Large	2
Towel	40 x 40 cm	2
Sponge	7,5 x 7,5 cm	10
Video Camera Cover	13 x 250 cm	1
Waste Bag	50 x 60 cm	1
Sterilization Wrap	100 x 100 cm	1

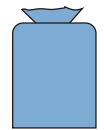
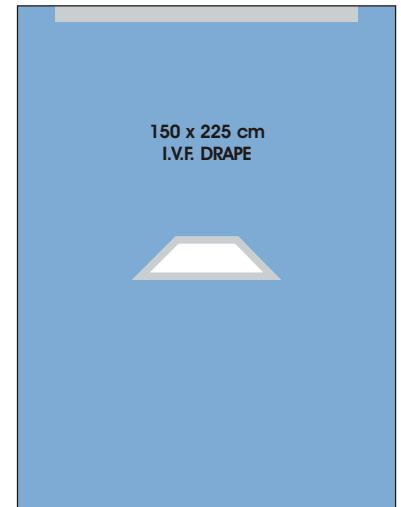

50 x 60 cm  
WASTE BAG

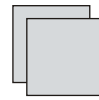

40 x 40 cm  
HAVLU / TOWEL

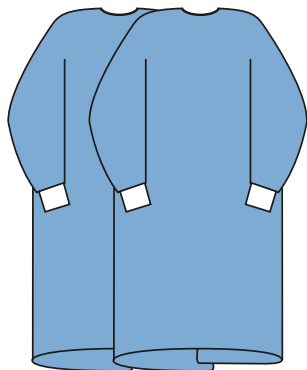

LARGE  
STANDARD SURGICAL GOWN



13 x 250 cm  
VIDEO CAMERA COVER



7,5 x 7,5 cm  
SPONGE X 10

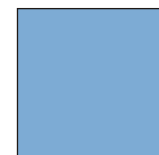

100 x 100 cm  
STERILIZATION WRAP



## Extremity Drape Set

CONTENT	SIZE	QUANTITY
Extremity Drape	200 x 300 cm	1
Drape With Adhesive Tape	150 x 180 cm	1
Back Table Cover	150 x 200 cm	1
Mayo Stand Cover	80 x 150 cm	1
Reinforced Surgical Gown	Large	2
Towel	40 x 40 cm	2
Op-tape	10 x 30 cm	2
Gauze Swabs	15 x 15 cm	10
Skin Marker & Ruler		1
Elastic Bandage	10 x 150 cm	1
Esmarch Bandage	5 x 200 cm	1
Sterilization Wrap	100 x 100 cm	1

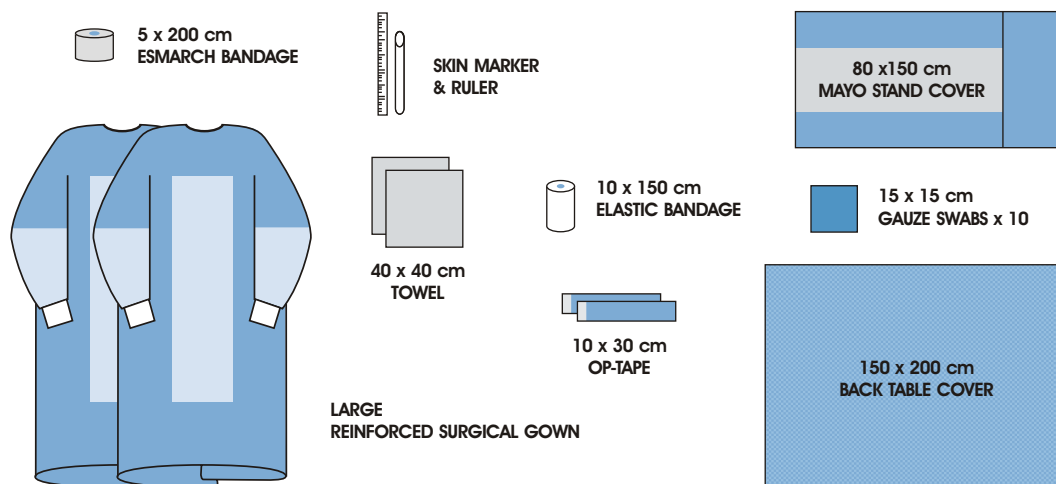
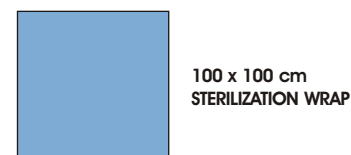
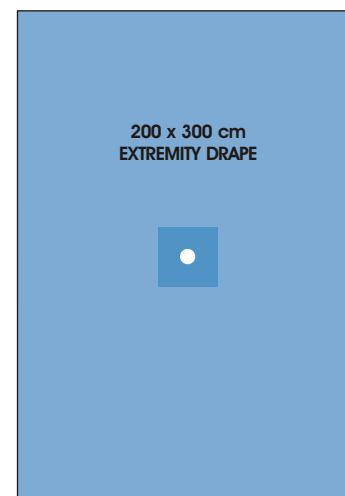

## Knee Drape Set

CONTENT	SIZE	QUANTITY
Extremity Drape	200 x 300 cm	1
Drape With Adhesive Tape	75 x 80 cm	2
Back Table Cover	150 x 200 cm	1
Mayo Stand Cover	80 x 150 cm	1
Reinforced Surgical Gown	Large	2
Towel	40 x 40 cm	2
Op-tape	10 x 30 cm	1
Gauze Spunch	15 x 15 cm	10
Elastic Bandage	10 x 150 cm	1
Esmarch Bandage	5 x 200 cm	1
Sterilization Wrap	100 x 100 cm	1

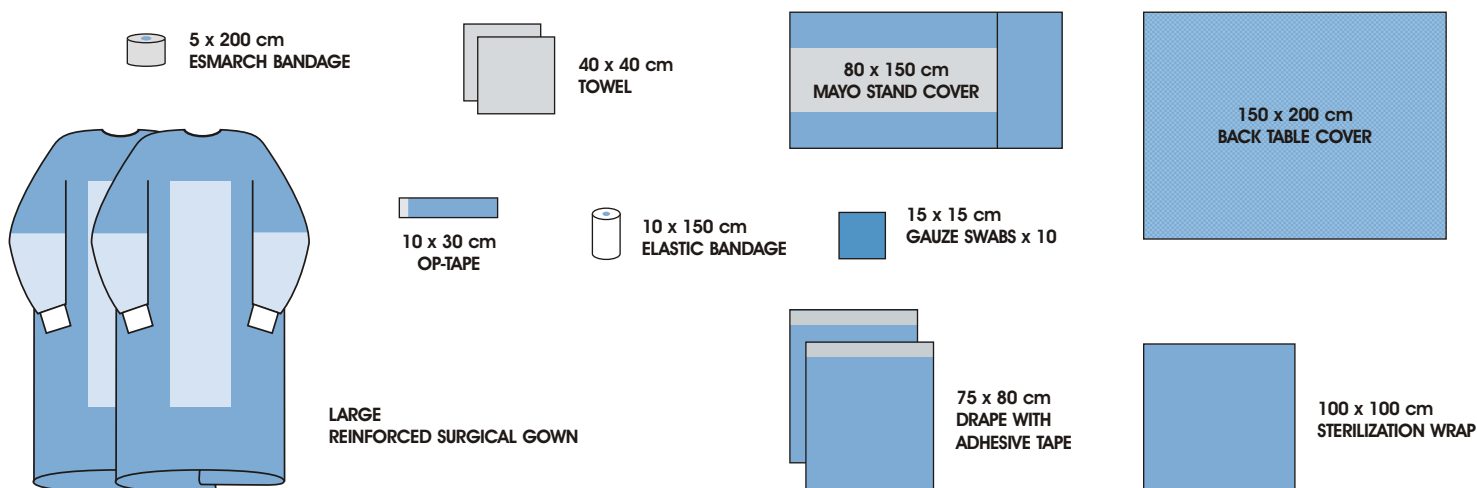
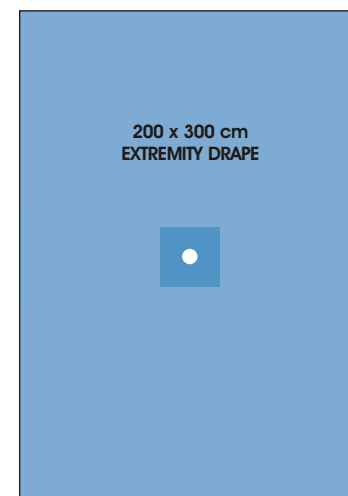

## Shoulder Drape Set

CONTENT	SIZE	QUANTITY
U Split Drape	200 x 300 cm	1
Drape With Adhesive Tape	75 x 100 cm	3
Back Table Cover	150 x 200 cm	1
Mayo Stand Cover	80 x 150 cm	1
Reinforced Surgical Gown	Large	2
Towel	40 x 40 cm	2
Op-tape	10 x 30 cm	2
Gauze Swabs	15 x 15 cm	5
Elastic Bandage	10 x 150 cm	1
Sterilization Wrap	100 x 100 cm	1

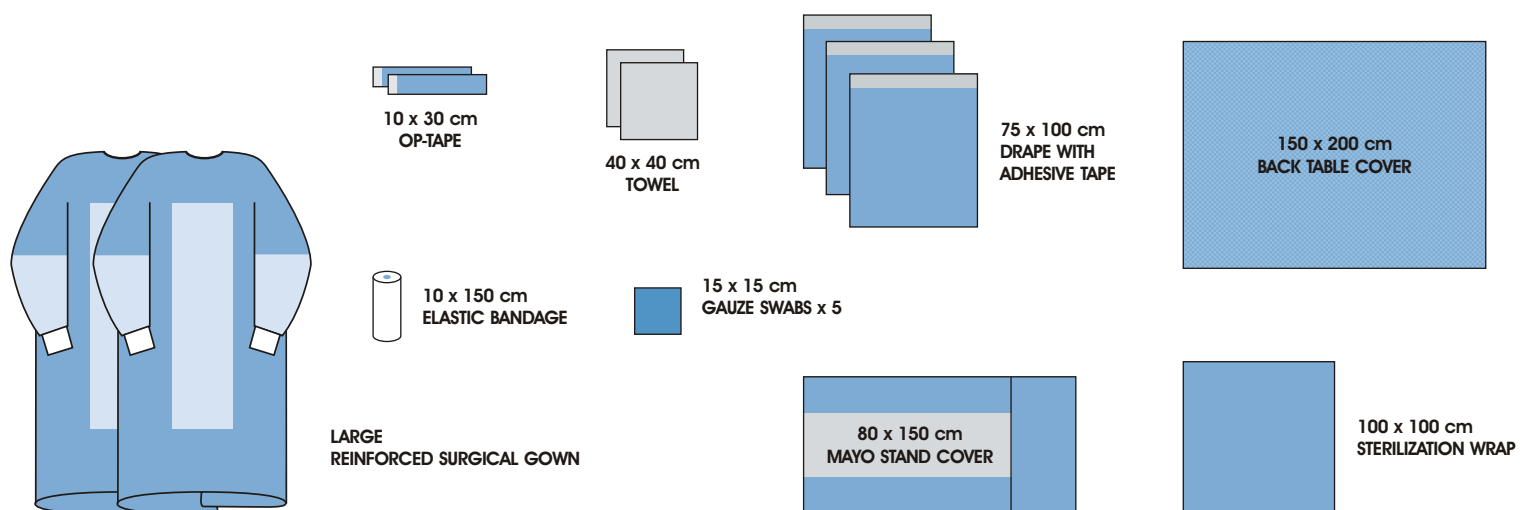
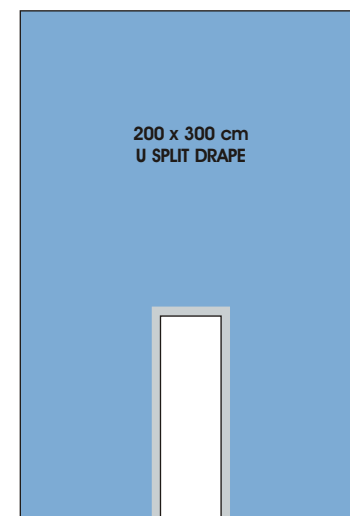

# Arthroplasty (Hip) Drape Set



CONTENT	SIZE	QUANTITY
Anesthesia Drape With Adhesive Tape	200 x 300 cm	1
U Split Drape	200 x 250 cm	1
U Split Drape With Pouch	200 x 250 cm	1
Hip Drape	240 x 300 cm	1
Foot Drape With Adhesive Tape	150 x 180 cm	1
Back Table Cover	150 x 200 cm	1
Mayo Stand Cover	80 x 150 cm	1
Reinforced Surgical Gown	Large	3
Towel	40 x 40 cm	2
Stockinettes	40 x 80 cm	2
Skin Marker & Ruler		1
Elastic Bandage	10 x 150 cm	1
Waste Bag	35 x 38 cm	1
Sterilization Wrap	100 x 100 cm	1

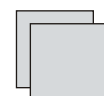

40 x 40 cm TOWEL



35 x 38 cm WASTE BAG



10 x 150 cm ELASTIC BANDAGE

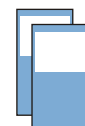

40 x 80 cm STOCKINETTES

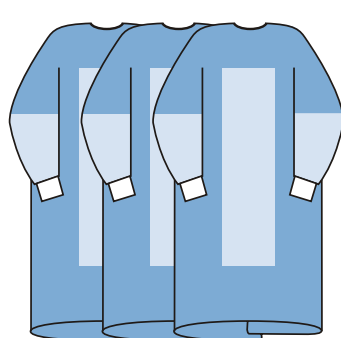
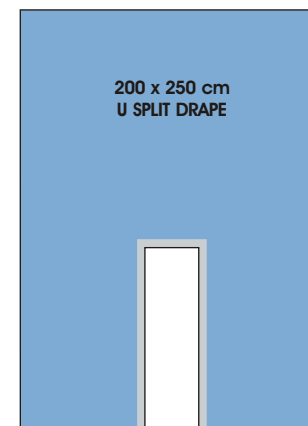
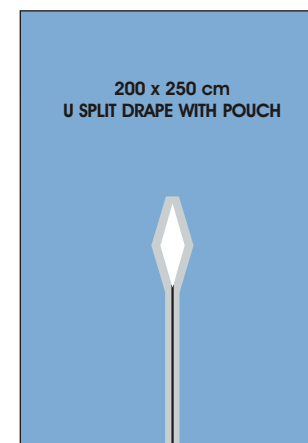

LARGE REINFORCED SURGICAL GOWN

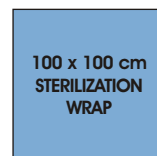
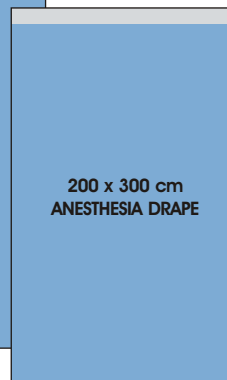
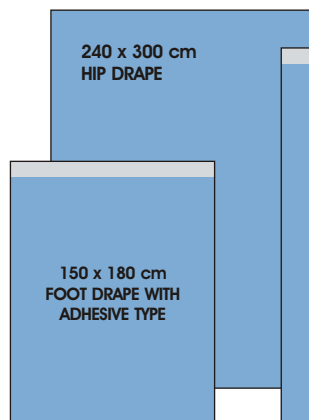

SKIN MARKER & RULER



# Vertebra Drape Set

CONTENT	SIZE	QUANTITY
Anesthesia Drape	150 x 240 cm	1
U Split Drape	200 x 300 cm	1
Foot Drape	150 x 180 cm	1
Drape With Adhesive Tape	100 x 120 cm	2
Drape With Adhesive Tape	75 x 100 cm	2
Back Table Cover	150 x 200 cm	1
Mayo Stand Cover	80 x 150 cm	1
Standard Surgical Gown	Large	2
Towel	40 x 40 cm	2
Op-tape	10 x 30 cm	2
Skin Marker & Ruler		1
Towel Clamp		2
Waste Bag	50 x 60 cm	2
Sterilization Wrap	100 x 100 cm	1

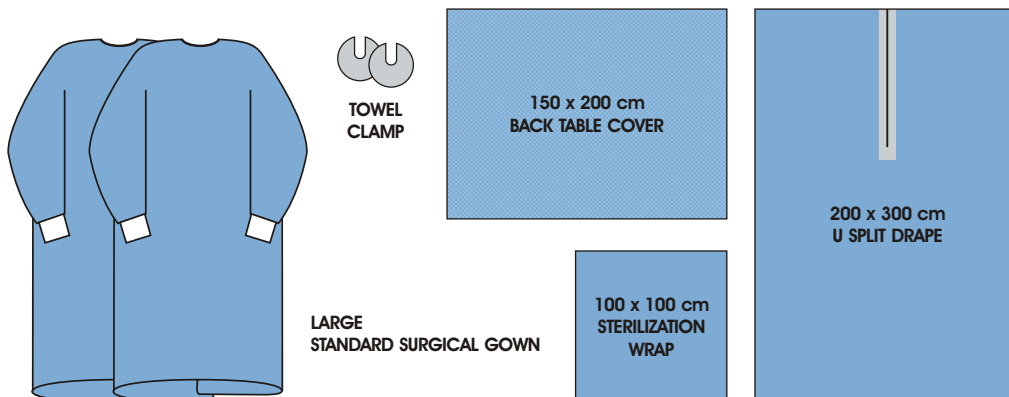
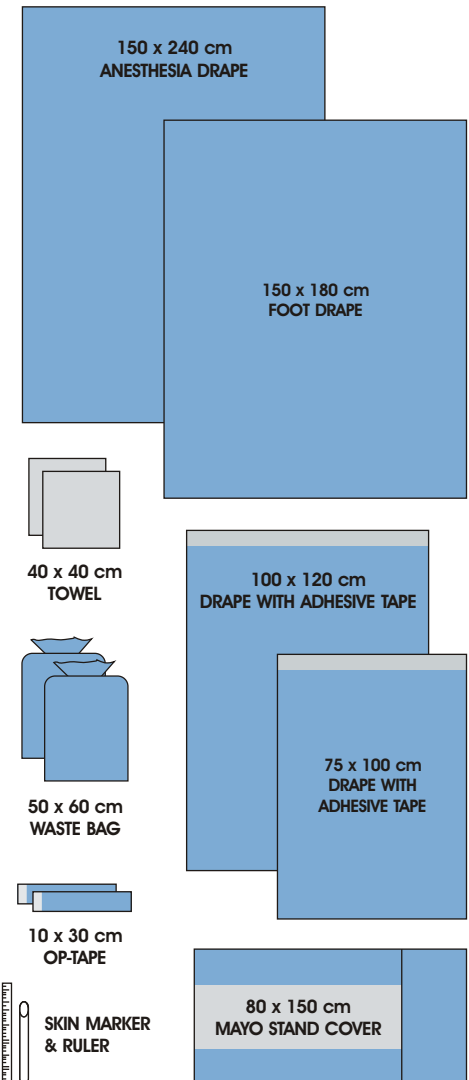

# Arthroscopy Drape Set



CONTENT	SIZE	QUANTITY
Arthroscopy Drape	200 x 300 cm	1
Back Table Cover	150 x 200 cm	1
Reinforced Surgical Gown	Large	2
Towel	40 x 40 cm	2
Op-tape	10 x 30 cm	2
Stockinettes	40 x 80 cm	2
Video Camera Cover	13 x 250 cm	1
Skin Marker & Ruler		1
Elastic Bandage	10 x 150 cm	1
Sterilization Wrap	100 x 100 cm	1

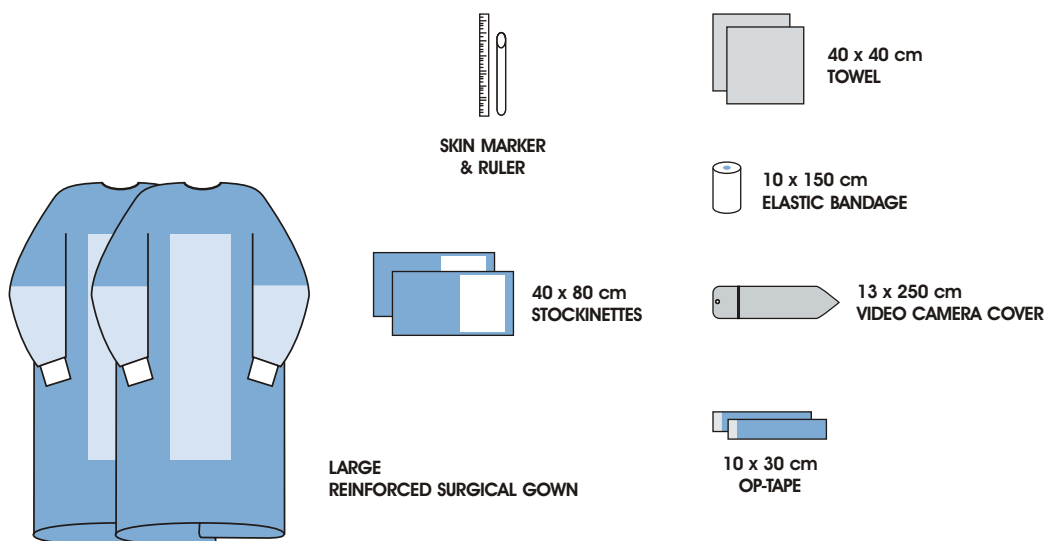
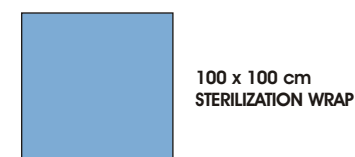
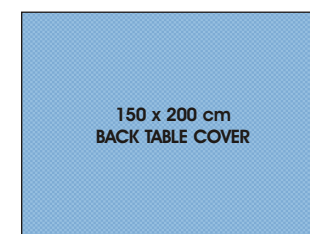
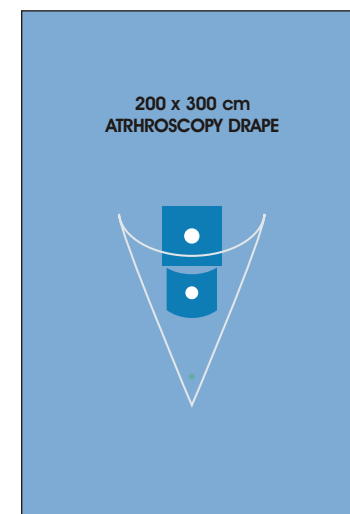

# Hand Surgery Drape Set

CONTENT	SIZE	QUANTITY
Upper Extremity Drape	200 x 300 cm	1
Drape With Adhesive Tape	150 x 240 cm	2
Drape With Adhesive Tape	75 x 90 cm	2
Back Table Cover	150 x 200 cm	1
Mayo Stand Cover	80 x 150 cm	1
Reinforced Surgical Gown	Large	3
Towel	40 x 40 cm	2
Op-tape	10 x 30 cm	2
Sterilization Wrap	100 x 100 cm	1

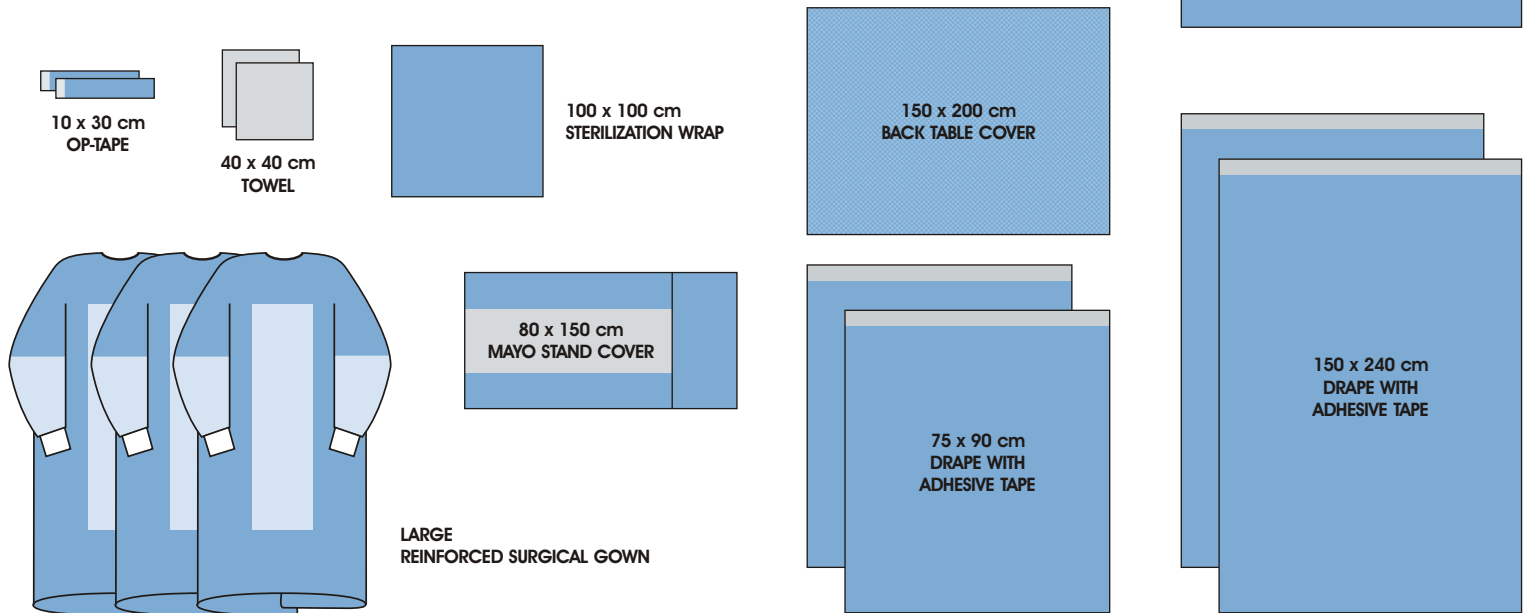
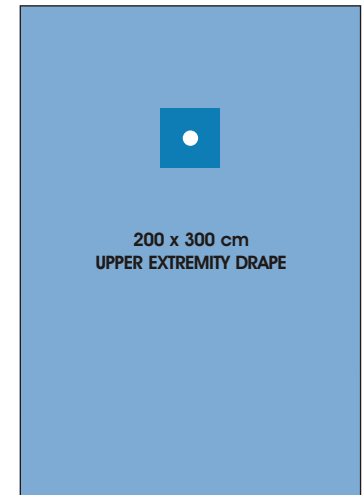

## Minor Surgery Drape Set



CONTENT	SIZE	QUANTITY
Fenestrated Drape	75 x 75 cm	1
Back Table Cover	75 x 100 cm	1
Reinforced Surgical Gown	Large	1
Towel	40 x 40 cm	1
Sterilization Wrap	50 x 50 cm	1

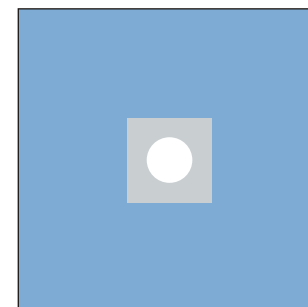

75 x 75 cm  
FENESTRATED DRAPE



40 x 40 cm  
TOWEL

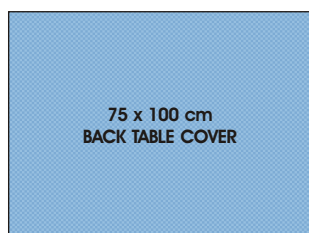

75 x 100 cm  
BACK TABLE COVER

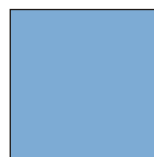

50 x 50 cm  
STERILIZATION WRAP



LARGE  
REINFORCED SURGICAL GOWN

# Craniotomy Drape Set

CONTENT	SIZE	QUANTITY
Craniotomy Drape	200 x 300 cm	1
Drape With Adhesive Tape	50 x 50 cm	1
Back Table Cover	150 x 200 cm	1
Mayo Stand Cover	80 x 150 cm	1
Reinforced Surgical Gown	Large	2
Towel	40 x 40 cm	2
Op-tape	10 x 30 cm	1
Skin Marker & Ruler		1
Pouch Bag		1
Sterilization Wrap	100 x 100 cm	1

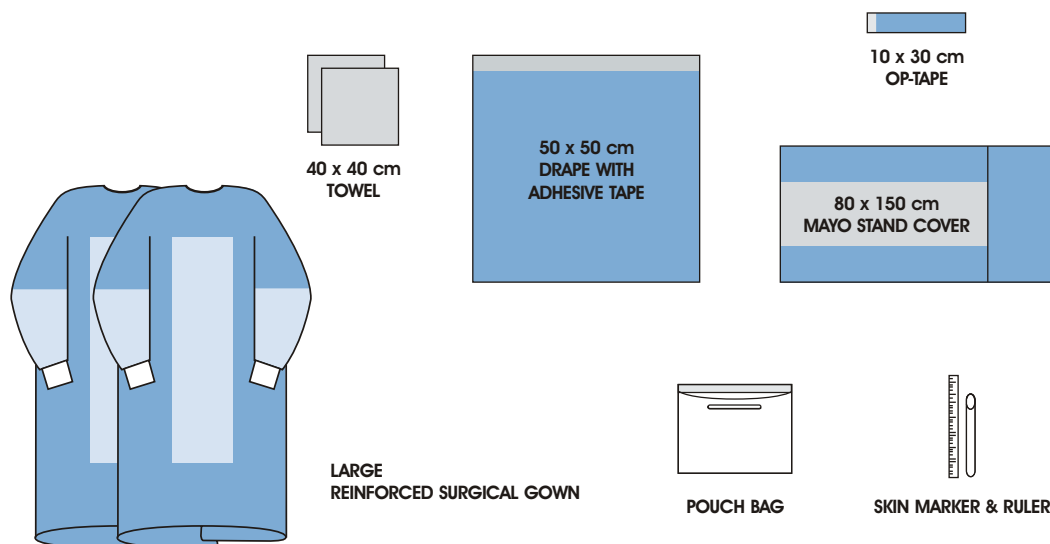
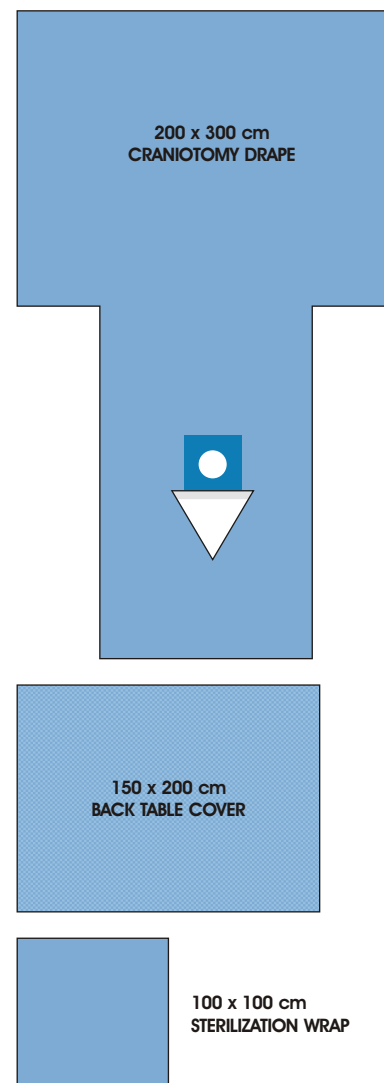

# Shunt Drape Set



CONTENT	SIZE	QUANTITY
Anesthesia Drape	150 x 240 cm	1
Shunt Drape	150 x 300 cm	1
Incision Drape	20 x 15 cm	1
Drape With Adhesive Tape	100 x 120 cm	2
Back Table Cover	150 x 200 cm	1
Mayo Stand Cover	80 x 150 cm	1
Reinforced Surgical Gown	Large	1
Towel	40 x 40 cm	2
Skin Marker & Ruler		1
Sterilization Wrap	100 x 100 cm	1

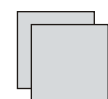

40 x 40 cm TOWEL



SKIN MARKER & RULER

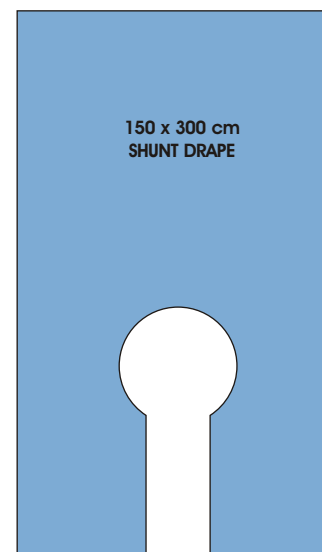

150 x 300 cm SHUNT DRAPE

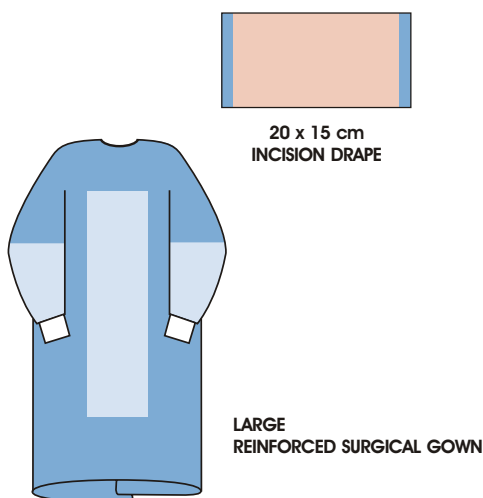

20 x 15 cm INCISION DRAPE

LARGE REINFORCED SURGICAL GOWN



150 x 240 cm ANESTHESIA DRAPE



100 x 120 cm DRAPE WITH ADHESIVE TAPE



80 x 150 cm MAYO STAND COVER

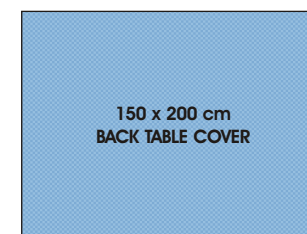

150 x 200 cm BACK TABLE COVER

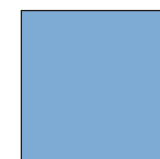

100 x 100 cm STERILIZATION WRAP

## E.N.T. (Ear Nose Throat) Drape Set



CONTENT	SIZE	QUANTITY
Split E.N.T. Drape	150 x 200 cm	1
Drape	100 x 100 cm	1
Fenestrated Drape	100 x 100 cm	1
Back Table Cover	150 x 200 cm	1
Reinforced Surgical Gown	Large	2
Towel	40 x 40 cm	2
Op-tape	10 x 30 cm	2
Sterilization Wrap	100 x 100 cm	1

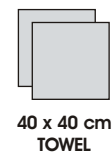
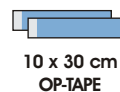
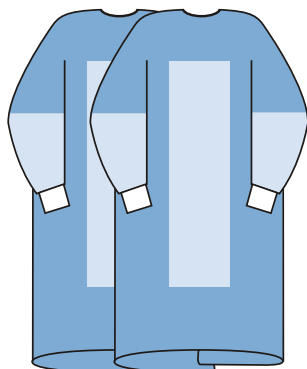
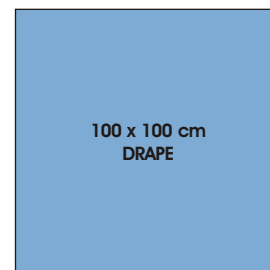
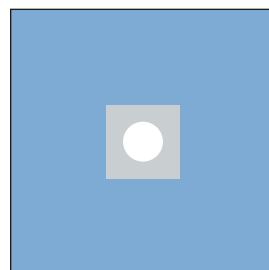
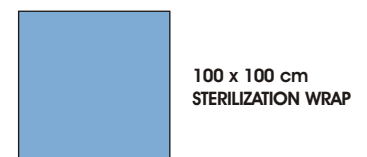
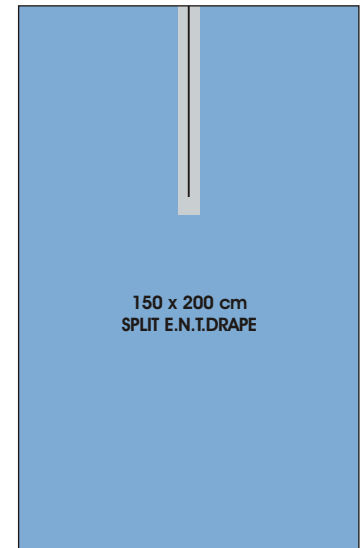

ELB2021™

## Eye Drape With Pouch



CODE	CONTENT	SIZE	QUANTITY
ELB2021	Eye Drape With Pouch	100 x 150 cm	1
ELB2021-2	Eye Drape With Pouch	150 x 150 cm	1

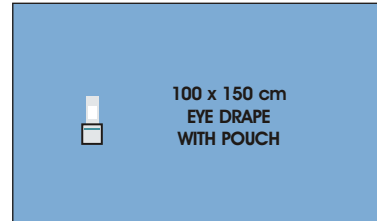
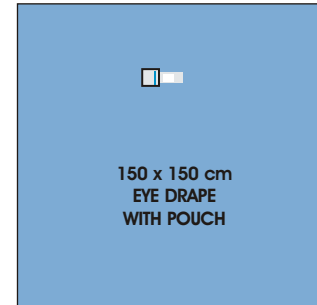

## Eye Drape With Double Pouch

CODE	CONTENT	SIZE	QUANTITY
ELB2022	Eye Drape With Double Pouch	100 x 150 cm	1
ELB2022-2	Eye Drape With Double Pouch	150 x 150 cm	1

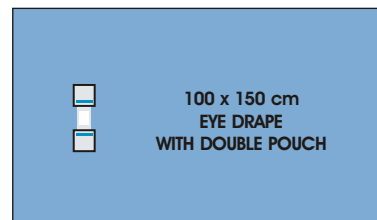
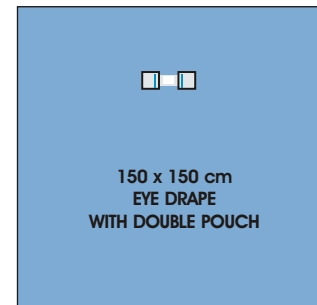

# Eye Drape Set



CONTENT	SIZE	QUANTITY
Eye Drape	100 x 130 cm	1
Drape	150 x 180 cm	1
Back Table Cover	150 x 200 cm	1
Standard Surgical Gown	Large	2
Towel	40 x 40 cm	1
Sterilization Wrap	100 x 100 cm	1

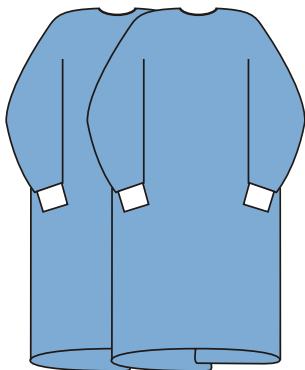
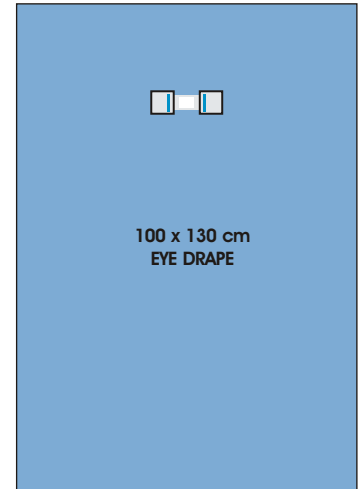

LARGE  
STANDARD SURGICAL GOWN



40 x 40 cm  
TOWEL

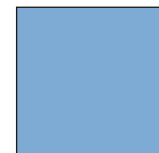
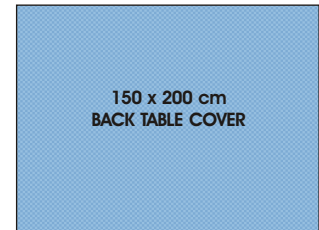
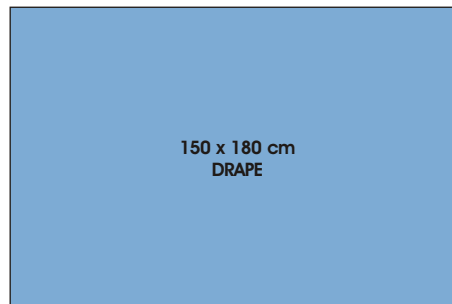

100 x 100 cm  
STERILIZATION WRAP

# Rhinoplasty Resection Drape Set



CONTENT	SIZE	QUANTITY
Rhinoplasty Drape	150 x 250 cm	1
Drape With Adhesive Tape	80 x 90 cm	1
Back Table Cover	75 x 100 cm	2
Mayo Stand Cover	80 x 150 cm	1
Reinforced Surgical Gown	Large	1
Towel	40 x 40 cm	1
Sterilization Wrap	75 x 75 cm	1

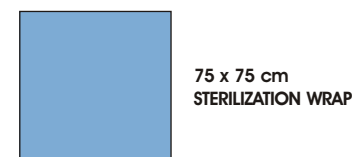
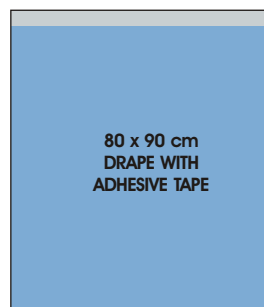
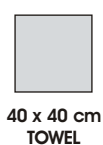
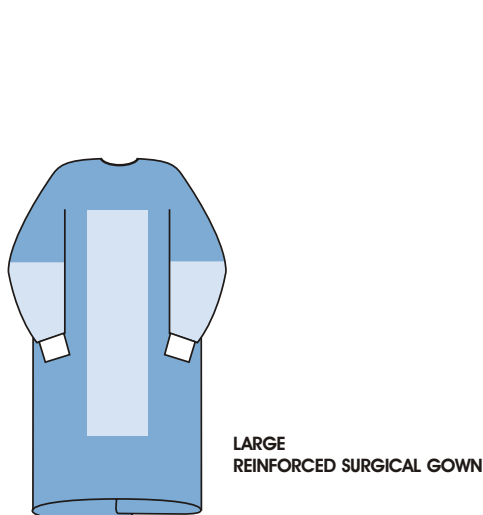
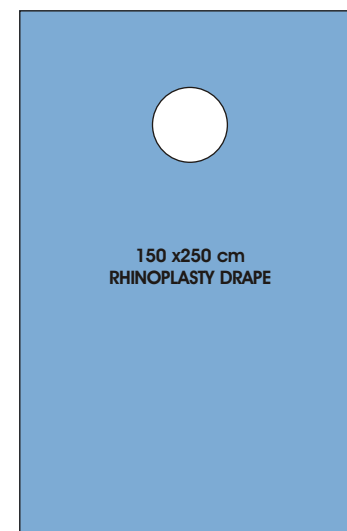

# Dental Drape Set



CONTENT	SIZE	QUANTITY
Fenestrated Dental Drape	150 x 150 cm	1
Drape With Adhesive Tape	150 x 150 cm	1
Back Table Cover	150 x 200 cm	1
Tool Tray Cover	50 x 50 cm	1
Reflector Drape	15 x 15 cm	2
Standard Surgical Gown	Large	1
Towel	40 x 40 cm	2
Patient Gown	65 x 110 cm	1
Gauze Swabs	15 x 15 cm	10
Transparent Pipe Cover	8 x 120 cm	2
Bonnet		1
Sterilization Wrap	100 x 100 cm	1

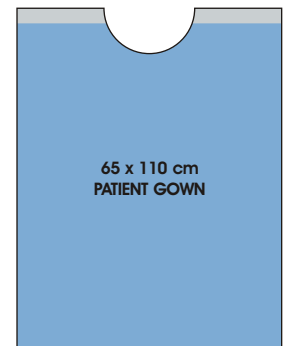
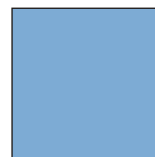
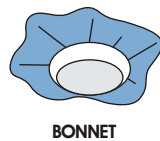
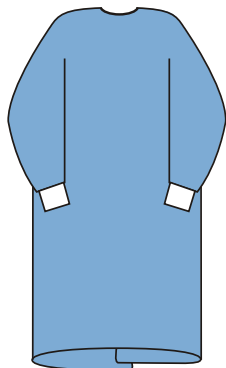
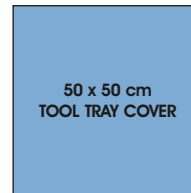
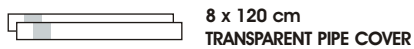
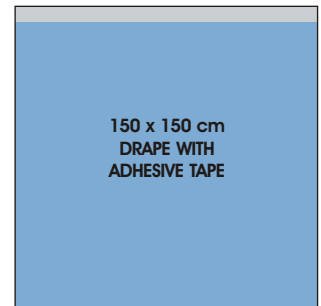
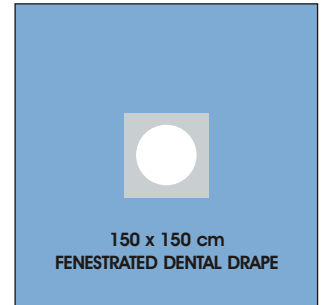

# Implant Drape Set



CONTENT	SIZE	QUANTITY
Tool Tray Cover	50 x 50 cm	1
Transparent Drape	100 x 120 cm	2
Reflector Drape	15 x 15 cm	2
Standard Surgical Gown	Large	1
Towel	40 x 40 cm	1
Patient Gown	65 x 110 cm	1
Gauze Swabs	15 x 15 cm	10
Sponge	7,5 x 7,5 cm	10
Bonnet		1
Sterilization Wrap	100 x 100 cm	1

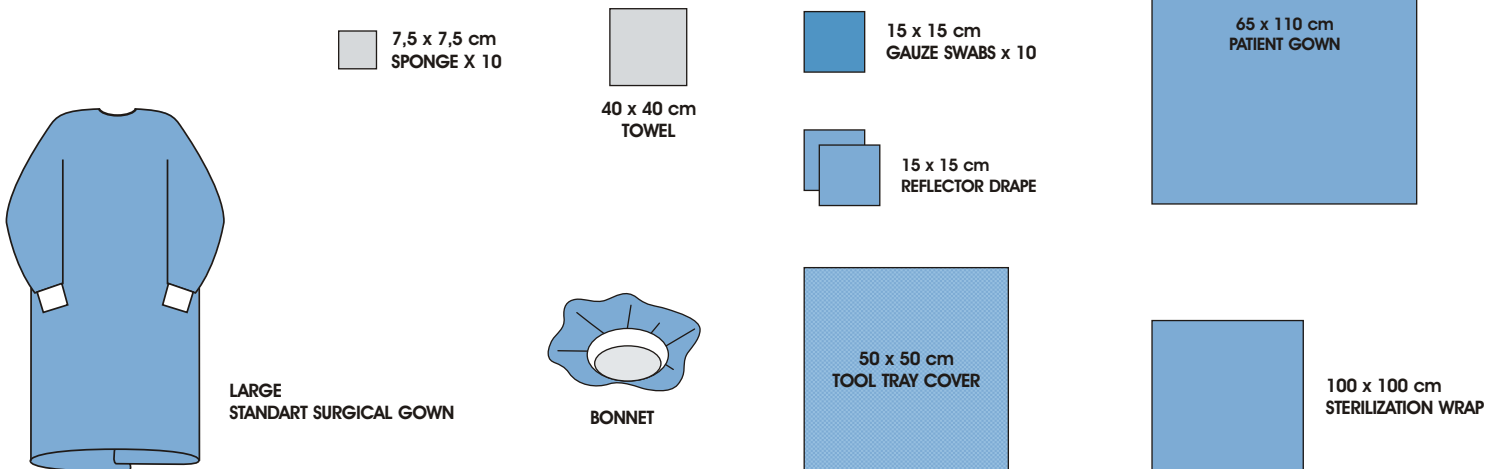
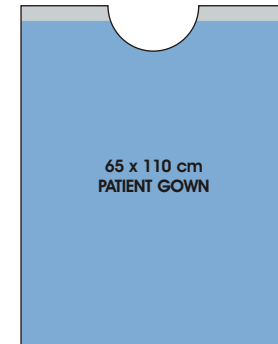
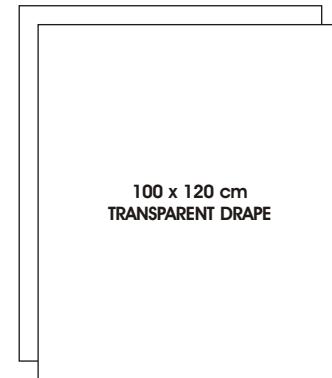



## Abdominal Drape Set

CONTENT	SIZE	QUANTITY
Abdominal Drape	150 x 240 cm	1
Drape With Adhesive Tape	150 x 180 cm	1
Drape With Adhesive Tape	75 x 100 cm	1
Back Table Cover	150 x 200 cm	1
Mayo Stand Cover	80 x 150 cm	1
Reinforced Surgical Gown	Large	2
Towel	40 x 40 cm	2
Op-tape	10 x 30 cm	2
Sterilization Wrap	100 x 100 cm	1

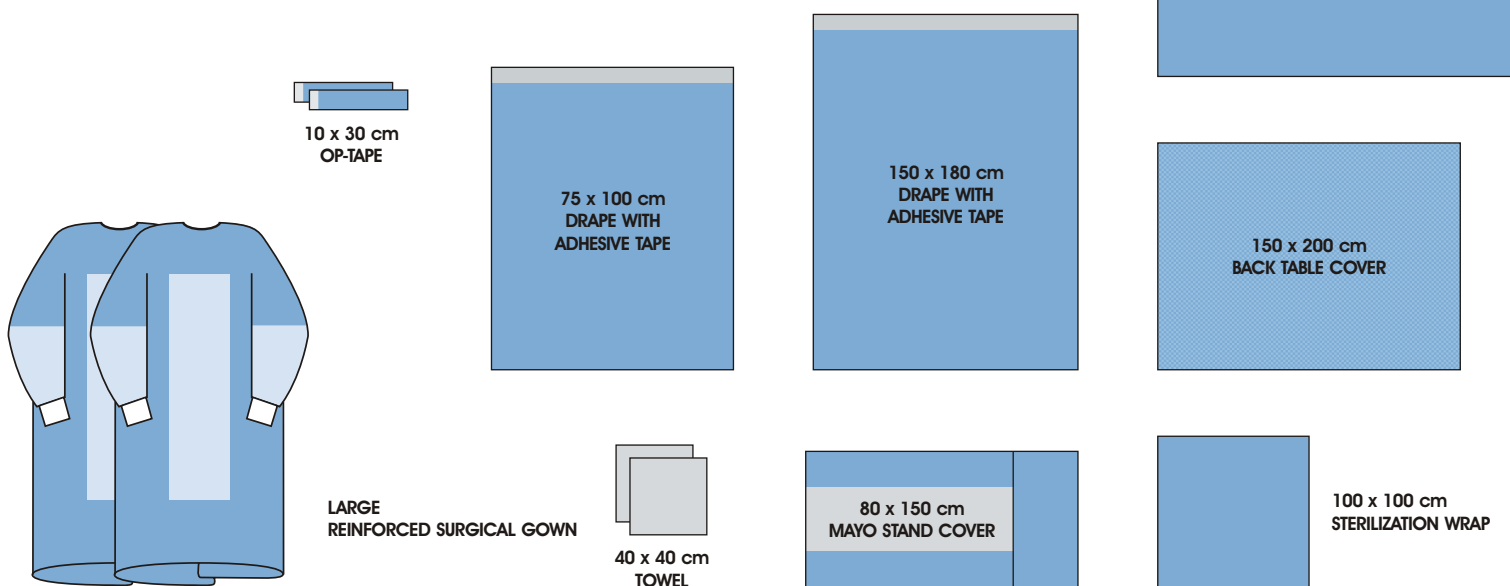

# Laparotomy Drape Set

CONTENT	SIZE	QUANTITY
Laparotomy Drape With Incise Film and Pouch	200 x 300 cm	1
Back Table Cover	150 x 200 cm	1
Reinforced Surgical Gown	Large	2
Towel	40 x 40 cm	2
Op-tape	10 x 30 cm	2
Gauze Swabs	7,5 x 7,5 cm	20
Sterilization Wrap	100 x 100 cm	1

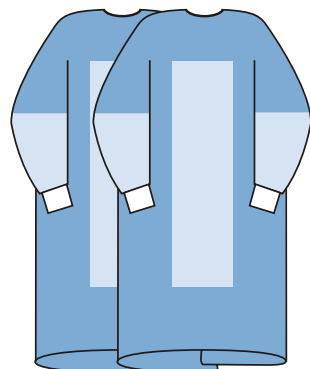
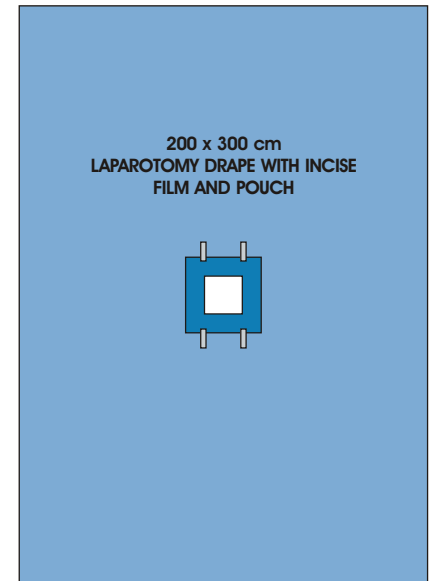

LARGE REINFORCED SURGICAL GOWN

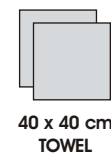
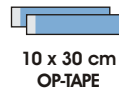
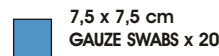

40 x 40 cm TOWEL

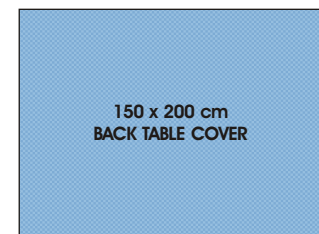

150 x 200 cm BACK TABLE COVER

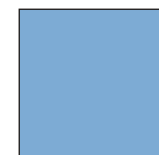

100 x 100 cm STERILIZATION WRAP

# Laparoscopy Drape Set



CONTENT	SIZE	QUANTITY
Laparoscopy Drape	200 x 300 cm	1
Back Table Cover	150 x 200 cm	1
Mayo Stand Cover	80 x 150 cm	1
Reinforced Surgical Gown	Large	2
Towel	40 x 40 cm	2
Op-tape	10 x 30 cm	2
Tube Holder Tape		2
Portable Bag		1
Sterilization Wrap	100 x 100 cm	1

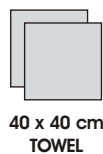
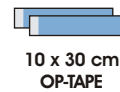
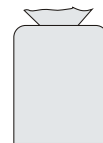
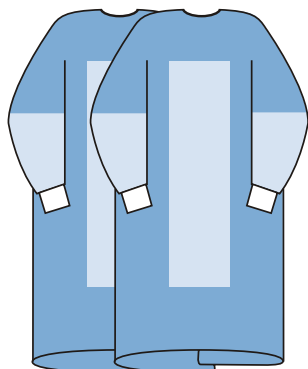
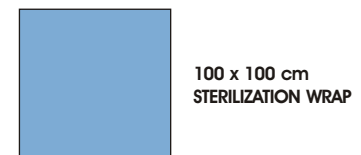
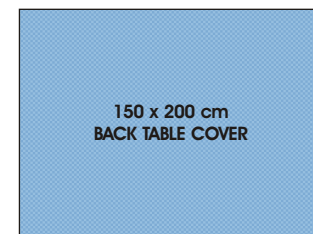
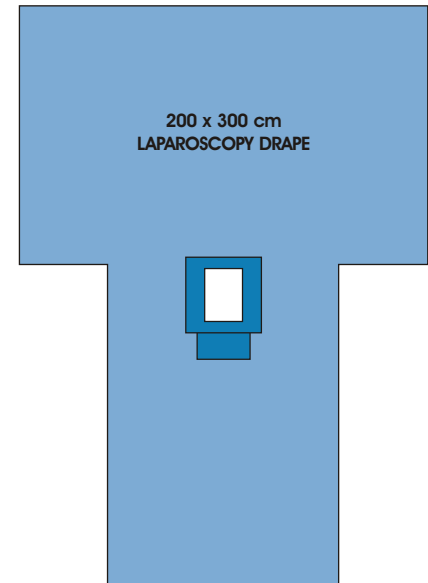

ELB2030™

## Percutaneous Drape Set



CONTENT	SIZE	QUANTITY
Percutaneous Drape	150 x 300 cm	1
Back Table Cover	150 x 200 cm	1
Reinforced Surgical Gown	Large	2
Towel	40 x 40 cm	2
Op-tape	10 x 30 cm	1
Scopy Cover	50 x 80 cm	1
Video Camera Cover	13 x 250 cm	1
Sterilization Wrap	100 x 100 cm	1

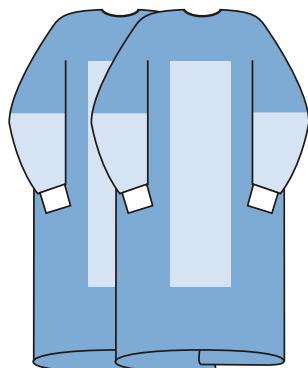
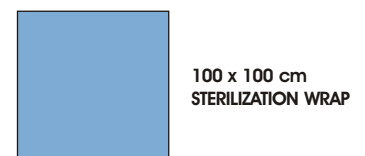
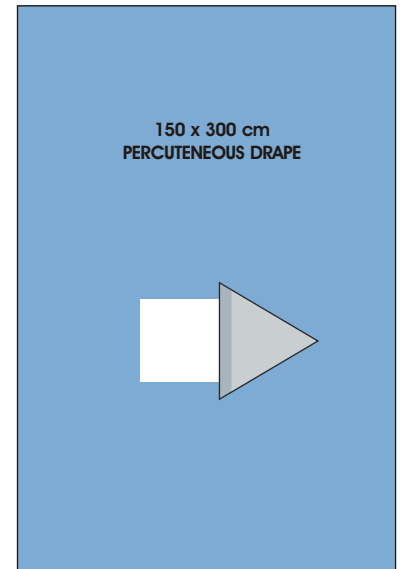

LARGE  
REINFORCED SURGICAL GOWN



13 x 250 cm  
VIDEO CAMERA COVER



50 x 80 cm  
SCOPY COVER



10 x 30 cm  
OP-TAPE

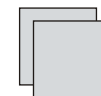

40 x 40 cm  
TOWEL

ELB2031™

## Transurethral Resection Drapes Set



CONTENT	SIZE	QUANTITY
T.U.R. Drape	200 x 240 cm	1
Drape	100 x 120 cm	1
Back Table Cover	150 x 200 cm	1
Reinforced Surgical Gown	Large	2
Towel	40 x 40 cm	2
Sterilization Wrap	100 x 100 cm	1

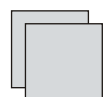
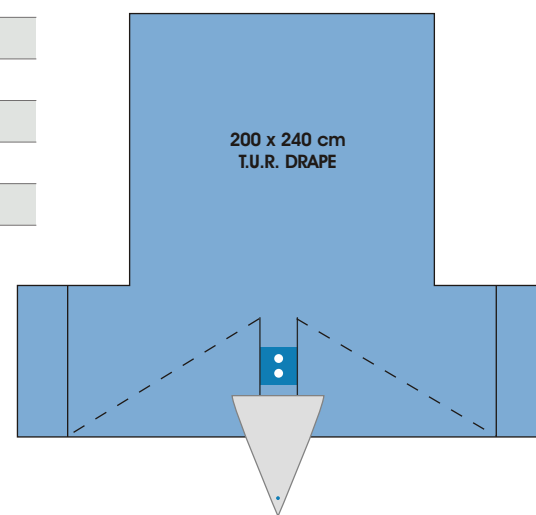

40 x 40 cm  
TOWEL

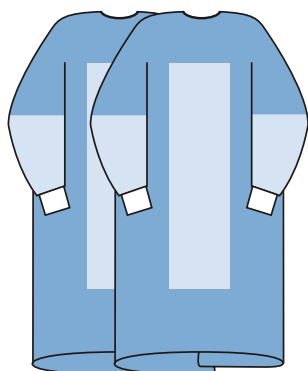

LARGE  
REINFORCED SURGICAL GOWN

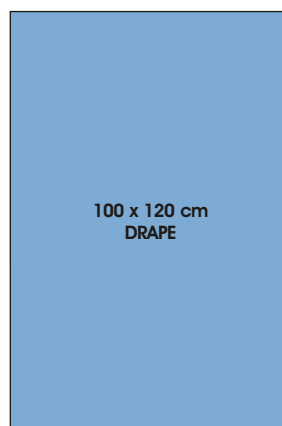

100 x 120 cm  
DRAPE



150 x 200 cm  
BACK TABLE COVER

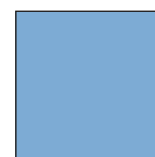

100 x 100 cm  
STERILIZATION WRAP

ELB2032™

## Cystoscopy Drape Set



CONTENT	SIZE	QUANTITY
Cystoscopy Drape	75 x 150 cm	1
Drape	100 x 120 cm	1
Leg Cover	50 x 100 cm	2
Back Table Cover	150 x 200 cm	1
Reinforced Surgical Gown	Large	2
Towel	40 x 40 cm	2
Op-tape	10 x 30 cm	1
Sterilization Wrap	100 x 100 cm	1

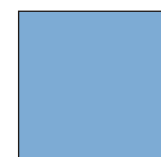
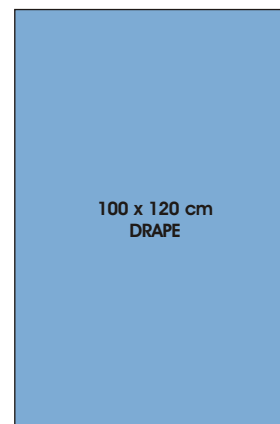
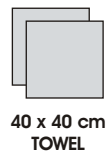
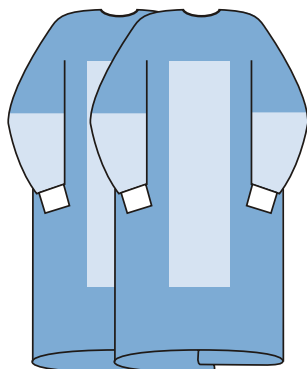
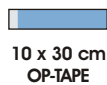
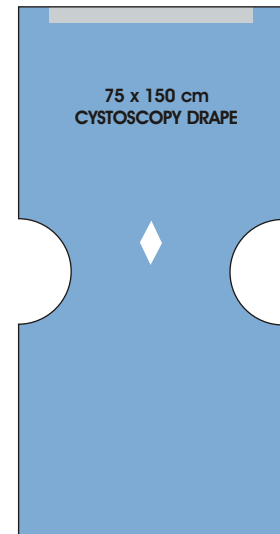

ELB2033™

## Chemotherapy Drape Set



CONTENT	SIZE	QUANTITY
Chemotherapy Drape	75 x 75 cm	1
Working Footer	40 x 120 cm	1
Reinforced Surgical Gown	Large	2
Towel	40 x 40 cm	2
Protective Glasses		1
Bonnet		1
Waste Bag	50 x 60 cm	1
Sterilization Wrap	100 x 100 cm	1

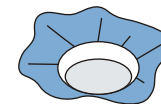
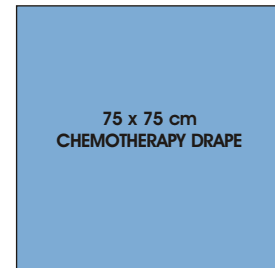

BONNET

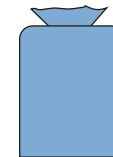

50 x 60 cm  
WASTE BAG

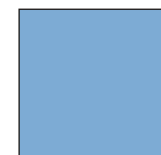

100 x 100 cm  
STERILIZATION WRAP

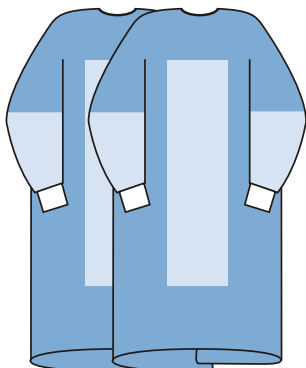

LARGE  
REINFORCED SURGICAL GOWN

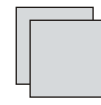

40 x 40 cm  
TOWEL

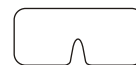

PROTECTIVE GLASSES

## Biopsy (Tese) Drape Set



CONTENT	SIZE	QUANTITY
Anesthesia Drape	150 x 240 cm	1
Fenestrated Drape	80 x 100 cm	1
Back Table Cover	150 x 200 cm	1
Standard Surgical Gown	Large	2
Towel	40 x 40 cm	2
Bowl	60 cc	1
Gauze Swabs	20 x 20 cm	5
Towel Clamp		2
Sterilization Wrap	75 x 75 cm	1

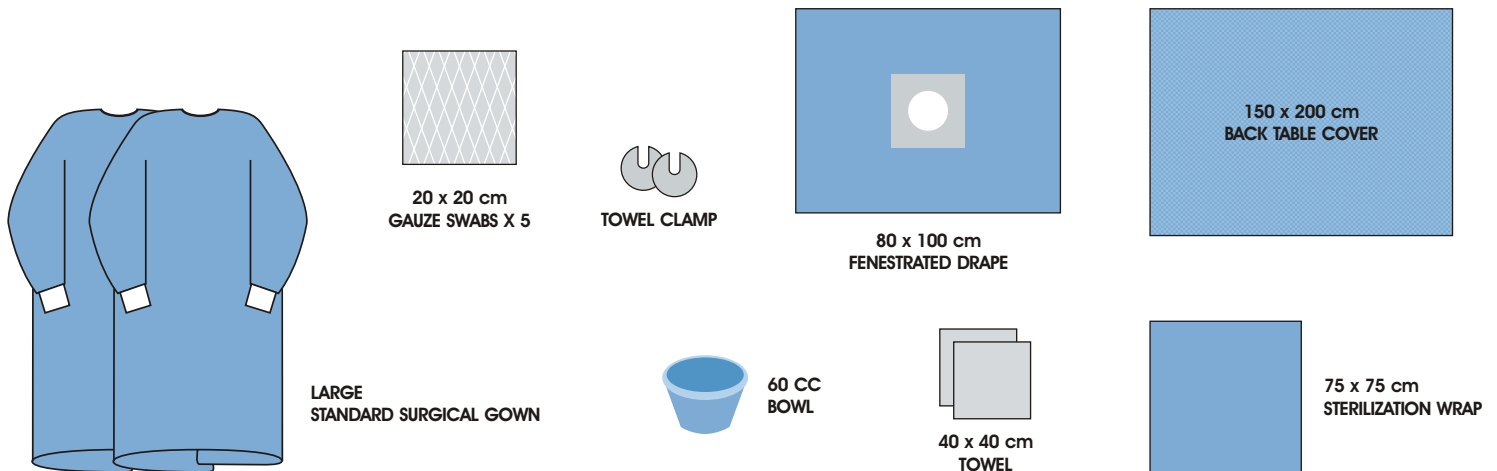
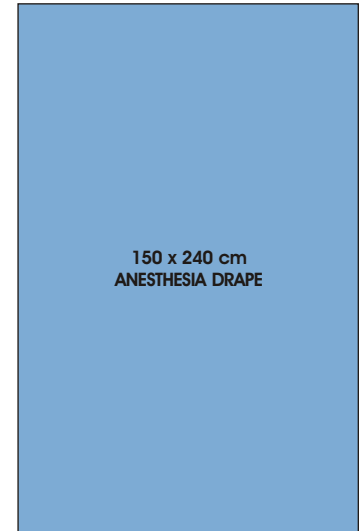

ELB2035™

## Dressing Drape Set



CONTENT	SIZE	QUANTITY
Fenestrated Drape With Adh. Tape	60 x 60 cm	1
Towel	40 x 40 cm	1
Sponge	7,5 x 7,5 cm	5
Solution Bowl	250 cc	1
Betadine Sponge		1
Waste Bag	30 x 35 cm	1
Sterilization Wrap	50 x 50 cm	1



40 x 40 cm  
TOWEL



30 x 35 cm  
WASTE BAG

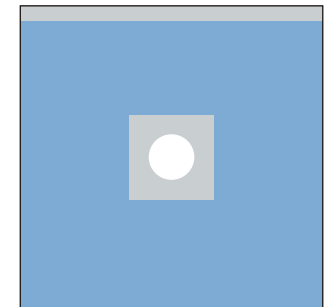

60 x 60 cm  
FENESTRATED DRAPE  
WITH ADHESIVE TAPE



BETADINE SPONGE



250 CC  
SOLUTION BOWL



7,5 x 7,5 cm  
SPONGE X 5



50 x 50 cm  
STERILIZATION WRAP

ELB2036™

## Hair Drape Set

CONTENT	SIZE	QUANTITY
Drape	100 x 150 cm	1
Transparent Drape	30 x 30 cm	1
Back Table Cover	75 x 100 cm	1



75 x 100 cm  
BACK TABLE COVER

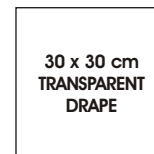

30 x 30 cm  
TRANSPARENT  
DRAPE

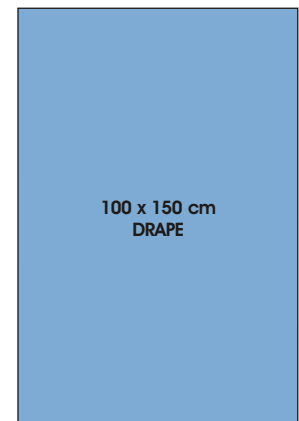

100 x 150 cm  
DRAPE







**Elbimed Personal Protective Equipments** offer well-designed solutions that support mobility and provide reliable protection, ensuring a safe user experience.



## Personal Protective Equipments (PPE)



	<p><b>ELB001</b></p> <p>Non-Strerile Fluid Resistant Single Use Visitor Gown 30-35 Gr SS / SMS</p>		<p><b>ELB002</b></p> <p>Non-Strerile Fluid Resistant Single Use Isolation Gown (Knitted Cuffs) 40-45 Gr SS / SMS</p>
	<p><b>ELB003</b></p> <p>Non-Strerile Fluid Resistant Single Use Isolation Gown (Knitted Cuffs) 40 Gr SMS Reinforced</p>		<p><b>ELB004</b></p> <p>Non-Strerile Fluid Resistant Single Use Isolation Gown (Knitted Cuffs) 45 Gr SMS Laminated</p>



## Personal Protective Equipments (PPE)



**ELB005**  
Disposable  
Protective Coverall  
With Welding Tape



**ELB006**  
Disposable Protective  
Coverall-Stitched



**ELB007**  
Disposable  
Protective Anti-Slip  
Overboots  
With Welding Tape



**ELB008**  
Shoe Cover  
PVC



## Personal Protective Equipments (PPE)



	<p><b>ELB009</b> Fluid Resistant Single Use Bonnet</p>		<p><b>ELB010</b> FFP2 Face Mask With Valve</p>
	<p><b>ELB011</b> FFP2 Face Mask Without Valve</p>		<p><b>ELB012</b> 3 PLY Medical Mask New Generation</p>
	<p><b>ELB013</b> Without Valve Single Use Protective Goggles</p>		<p><b>ELB014</b> Colonoscopy Shorts</p>

Elbimed is an affiliated company  
of the **Elbi Group**.

ELBI PHARMA • ELBIMED • ELBI MEDICAL • ELH DRUGS • ELBI ALUMINUM

 **elbimed**

**HEAD OFFICE**

Alacaatlı Mahallesi 4916. Sokak No:1, 06810 Çankaya, ANKARA / TÜRKİYE  
Tel: +90 (312) 447 96 78 • Fax : +90 (312) 447 96 68

**FACTORY**

ALCI OSB Mahallesi 2000. Cadde No:16 06930 Sincan, ANKARA / TÜRKİYE  
E-mail: [elbi@elbipharma.com](mailto:elbi@elbipharma.com) • [elbi@elbimed.com](mailto:elbi@elbimed.com)

[www.elbimed.com](http://www.elbimed.com) | [www.elbipharma.com](http://www.elbipharma.com) |   [elbipharma](https://www.linkedin.com/company/elbipharma)

 **elbi**  
pharma