



# datka®

[www.datka.com.tr](http://www.datka.com.tr)

**NEW**  
GENERATION



PRODUCT CATALOGUE

Your Reliable Partner in



SINCE 2014

# BALL VALVES



**Product Name**  
Ball Valve Coupling

Product Code	Features	Box Quantity
DTK1013	20 x 20	120
DTK1023	25 x 25	90
DTK1033	32 x 32	60
DTK1043	40 x 40	35
DTK1053	50 x 50	28
DTK1063	63 x 63	14
DTK1073	75 x 75	8



**Product Name**  
Coupling Valve Female

Product Code	Features	Box Quantity
DTK1065	Ø63 - 2" FEMALE	16
DTK1075	Ø75 - 2 1/2" FEMALE	12



**Product Name**  
Male-Female Ball Valve

Product Code	Features	Box Quantity
DTK1031	1" x 1"	100



**Product Name**  
**Ball Valve**

Product Code	Features	Box Quantity
DTK1010	1/2" x 1/2"	150
DTK1020	3/4" x 3/4"	120
DTK1030	1" x 1"	70
DTK1040	1 1/4" x 1 1/4"	48
DTK1050	1 1/2" x 1 1/2"	42
DTK1060	2" x 2"	20
DTK1070	2 1/2" x 2 1/2"	12
DTK1080	3" x 3"	8
DTK1090	4" x 4"	4



**Product Name**  
**Steel Handle Ball Valve**

Product Code	Features	Box Quantity
DTK1032	1" x 1"	75
DTK1042	1 1/4" x 1 1/4"	50
DTK1052	1 1/2" x 1 1/2"	50
DTK1062	2" x 2"	20
DTK1072	2 1/2" x 2 1/2"	12
DTK1082	3" x 3"	8
DTK1092	4" x 4"	4

# BALL VALVES



## 2" METAL THREADED (ALUMINUM PLATING)

AĞIRLIK (KG) WEIGHT (KG)	ÜRÜN KODU PRODUCT CODE	BASINÇ PRESSURE	EBAT (mm) SIZE (mm)
1.041 KG	DTK4-4	PN16	2"

Metal (Aluminum Plating)Ball

FULL TRANSITIVE  
Полнопроходной



MADE OF

PP

Exclusive  
Product

## 1 1/2" PLASTIC THREADED

AĞIRLIK (KG) WEIGHT (KG)	ÜRÜN KODU PRODUCT CODE	BASINÇ PRESSURE	EBAT (mm) SIZE (mm)
0.654 KG	DTK3-3	PN16	1 1/2"

Metal (Aluminum Plating)Ball

FULL TRANSITIVE  
Полнопроходной



MADE OF

PP

Exclusive  
Product

## 1 1/4" PLASTIC THREADED

AĞIRLIK (KG) WEIGHT (KG)	ÜRÜN KODU PRODUCT CODE	BASINÇ PRESSURE	EBAT (mm) SIZE (mm)
0.455 KG	DTK2-2	PN16	1 1/4"

Metal (Aluminum Plating)Ball

FULL TRANSITIVE  
Полнопроходной



MADE OF

PP

Exclusive  
Product

## 1" PLASTIC THREADED

AĞIRLIK (KG) WEIGHT (KG)	ÜRÜN KODU PRODUCT CODE	BASINÇ PRESSURE	EBAT (mm) SIZE (mm)
0,190 KG	DTK1-1	PN16	1"

Metal (Aluminum Plating)Ball

FULL TRANSITIVE  
Полнопроходной



MADE OF

PP

Exclusive  
Product

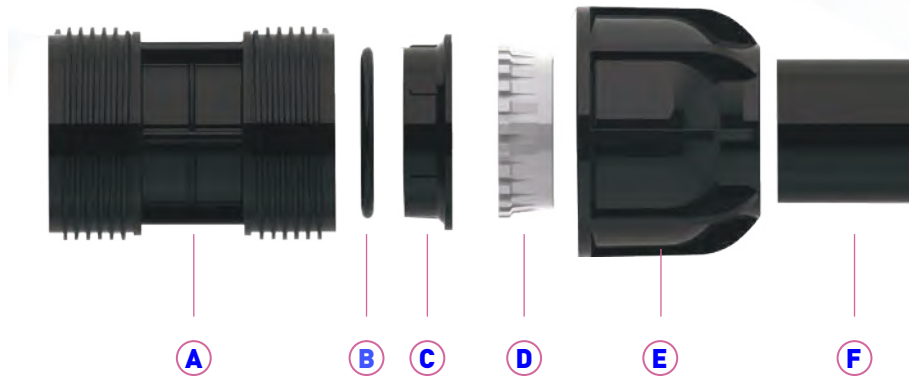

## TECHNICAL INFORMATION

WORKING PRESSURE : **PN 16**  
 DIAMETER RANGE : **Ø20 - Ø110 MM**

- |                        |                 |                  |
|------------------------|-----------------|------------------|
| <b>A</b> BODY          | <b>B</b> O-RING | <b>C</b> BLOCKER |
| <b>D</b> CLAMPING PART | <b>E</b> NUT    | <b>F</b> PIPE    |

## ASSEMBLY METHOD OF COMPRESSION FITTINGS



Cut the pipe using a cutting tool in vertical position to the pipe axis. Make sure that no burr remains at the end of the pipe.

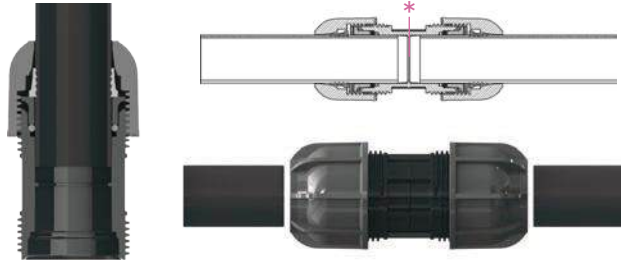

Loosen the nut of your compression fitting rotating approximately 4 full circles. Push the pipe properly until the **\*pipe retaining point inside the pipe**.

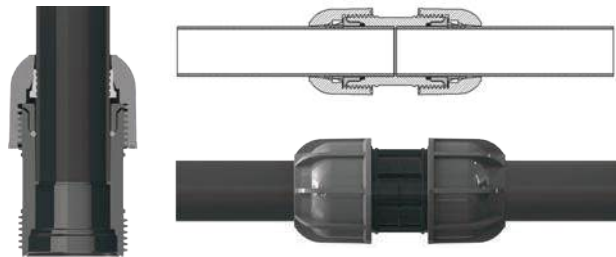

Tighten nut by hand (Tighten 32 mm and pipes bigger than 32 mm using Coupling wrench)

**MALE ADAPTER**

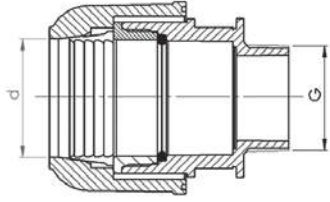

**FEMALE ADAPTER**

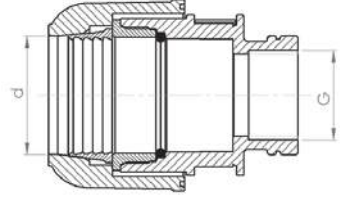

Product Code	Diameter d x G	Packing Quantity		
		Bag	Box	Sack
DTK-020-10001	20 x 1/2"	100	800	1000
DTK-020-10002	20 x 3/4"	100	800	1000
DTK-025-10005	25 x 1/2"	50	400	500
DTK-025-10006	25 x 3/4"	50	400	500
DTK-025-10007	25 x 1"	50	400	500
DTK-032-10011	32 x 1/2"	50	300	400
DTK-032-10012	32 x 3/4"	50	300	400
DTK-032-10013	32 x 1"	50	300	400
DTK-032-10014	32 x 1 1/4"	50	300	400
DTK-040-10021	40 x 1"	30	180	240
DTK-040-10022	40 x 1 1/4"	30	180	240
DTK-040-10023	40 x 1 1/2"	30	180	240
DTK-050-10032	50 x 1 1/4"	20	140	140
DTK-050-10033	50 x 1 1/2"	20	120	140
DTK-050-10035	50 x 2"	20	120	140
DTK-063-10044	63 x 1 1/4"	12	72	96
DTK-063-10045	63 x 1 1/2"	12	72	96
DTK-063-10047	63 x 2"	12	72	96
DTK-063-10049	63 x 2 1/2"	12	72	96
DTK-075-10059	75 x 2"	6	36	54
DTK-075-10061	75 x 2 1/2"	6	36	54
DTK-075-10063	75 x 3"	6	36	54
DTK-090-10075	90 x 2"	6	24	36
DTK-090-10077	90 x 2 1/2"	6	24	36
110-090-10079	90 x 3"	6	24	36
110-090-10083	90 x 4"	6	24	36
110-110-10091	110 x 2"	4	12	20
110-110-10093	110 x 2 1/2"	4	12	20
110-110-10095	110 x 3"	4	12	20
110-110-10099	110 x 4"	4	12	20

Product Code	Diameter d x G	Packing Quantity		
		Bag	Box	Sack
DTK-020-11001	20 x 1/2"	100	800	1000
DTK-020-11002	20 x 3/4"	100	800	1000
DTK-025-11005	25 x 1/2"	50	400	500
DTK-025-11006	25 x 3/4"	50	400	500
DTK-025-11007	25 x 1"	50	400	500
DTK-032-11012	32 x 3/4"	50	250	350
DTK-032-11013	32 x 1"	50	250	350
DTK-032-11014	32 x 1 1/4"	50	250	350
DTK-040-11021	40 x 1"	20	140	200
DTK-040-11022	40 x 1 1/4"	20	140	200
DTK-040-11023	40 x 1 1/2"	20	140	200
DTK-050-11032	50 x 1 1/4"	15	90	120
DTK-050-11033	50 x 1 1/2"	15	90	120
DTK-050-11035	50 x 2"	15	90	120
DTK-063-11045	63 x 1 1/2"	12	72	96
DTK-063-11047	63 x 2"	12	72	96
DTK-063-11049	63 x 2 1/2"	12	72	96
DTK-075-11059	75 x 2"	6	36	54
DTK-075-11061	75 x 2 1/2"	6	36	54
DTK-075-11063	75 x 3"	6	36	54
DTK-090-11075	90 x 2"	6	24	30
DTK-090-11077	90 x 2 1/2"	6	24	30
DTK-090-11079	90 x 3"	6	24	30
DTK-090-11083	90 x 4"	6	24	30
DTK-110-11091	110 x 2"	4	12	20
DTK-110-11093	110 x 2 1/2"	4	12	20
DTK-110-11095	110 x 3"	4	12	20
DTK-110-11099	110 x 4"	4	12	20

## COUPLING MALE TE

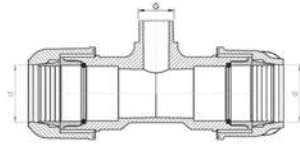

## COUPLING FEMALE TE

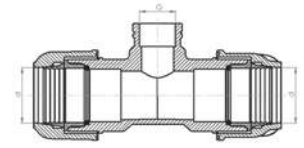

Product Code	Diameter d x G	Packing Quantity		
		Bag	Box	Sack
DTK-020-15001	20 x 1/2" x 20	30	300	360
DTK-020-15002	20 x 3/4" x 20	30	300	360
DTK-025-15005	25 x 1/2" x 25	20	160	200
DTK-025-15006	25 x 3/4" x 25	20	160	200
DTK-025-15007	25 x 1" x 25	20	160	200
DTK-025-15008	25 x 1 1/4" x 25	20	160	200
DTK-032-15012	32 x 3/4" x 32	20	120	140
DTK-032-15013	32 x 1" x 32	20	120	140
DTK-032-15014	32 x 1 1/4" x 32	20	120	140
DTK-040-15021	40 x 1" x 40	10	60	80
DTK-040-15022	40 x 1 1/4" x 40	10	60	80
DTK-040-15023	40 x 1 1/2" x 40	10	60	80
DTK-050-15031	50 x 1" x 50	4	40	52
DTK-050-15032	50 x 1 1/4" x 50	4	40	52
DTK-050-15033	50 x 1 1/2" x 50	4	40	52
DTK-050-15035	50 x 2" x 50	4	40	50
DTK-063-15044	63 x 1 1/4" x 63	4	24	32
DTK-063-15045	63 x 1 1/2" x 63	4	24	32
DTK-063-15047	63 x 2" x 63	4	24	32
DTK-063-15049	63 x 2 1/2" x 63	4	24	32
DTK-075-15059	75 x 2" x 75	2	12	18
DTK-075-15061	75 x 2 1/2" x 75	2	12	18
DTK-075-15063	75 x 3" x 75	2	12	18
DTK-090-15077	90 x 2 1/2" x 90	2	8	12
DTK-090-15079	90 x 3" x 90	2	8	12
DTK-090-15083	90 x 4" x 90	2	8	12
DTK-110-15093	110x2 1/2"x110	2	4	8
DTK-110-15095	110 x 3" x 110	2	4	8
DTK-110-15099	110 x 4" x 110	2	4	8

Product Code	Diameter d x G	Packing Quantity		
		Bag	Box	Sack
DTK-020-16001	20 x 1/2" x 20	30	300	360
DTK-020-16002	20 x 3/4" x 20	30	300	360
DTK-025-16005	25 x 1/2" x 25	20	160	200
DTK-025-16006	25 x 3/4" x 25	20	160	200
DTK-025-16007	25 x 1" x 25	20	160	200
DTK-032-16011	32 x 1/2" x 32	20	100	140
DTK-032-16012	32 x 3/4" x 32	20	100	140
DTK-032-16013	32 x 1" x 32	20	100	140
DTK-032-16014	32 x 1 1/4" x 32	20	100	140
DTK-040-16020	40 x 3/4" x 40	10	60	80
DTK-040-16021	40 x 1" x 40	10	60	80
DTK-040-16022	40 x 1 1/4" x 40	10	60	80
DTK-040-16023	40 x 1 1/2" x 40	10	60	80
DTK-050-16030	50 x 3/4" x 50	4	36	48
DTK-050-16031	50 x 1" x 50	4	36	48
DTK-050-16032	50 x 1 1/4" x 50	4	36	48
DTK-050-16033	50 x 1 1/2" x 50	4	36	48
DTK-050-16035	50 x 2" x 50	4	36	48
DTK-063-16043	63 x 1" x 63	4	24	32
DTK-063-16044	63 x 1 1/4" x 63	4	24	32
DTK-063-16045	63 x 1 1/2" x 63	4	24	32
DTK-063-16047	63 x 2" x 63	4	24	32
DTK-063-16049	63 x 2 1/2" x 63	4	24	32
DTK-075-16059	75 x 2" x 75	2	12	18
DTK-075-16061	75 x 2 1/2" x 75	2	12	18
DTK-075-16063	75 x 3" x 75	2	12	18
DTK-090-16077	90 x 2 1/2" x 90	2	8	12
DTK-090-16079	90 x 3" x 90	2	8	12
DTK-090-16083	90 x 4" x 90	2	8	12
DTK-110-16093	110x2 1/2"x110	1	4	8
DTK-110-16095	110 x 3" x 110	1	4	8
DTK-110-16099	110 x 4" x 110	1	4	8

## COUPLING TE



Product Code	Diameter	Packing Quantity		
		Bag	Box	Sack
DTK-020-13000	20 x 20 x 20	30	240	300
DTK-025-13004	25 x 25 x 25	20	120	180
DTK-032-13010	32 x 32 x 32	12	72	108
DTK-040-13018	40 x 40 x 40	10	60	80
DTK-050-13028	50 x 50 x 50	4	36	48
DTK-063-13040	63 x 63 x 63	4	24	32
DTK-075-13052	75 x 75 x 75	2	10	14
DTK-090-13068	90 x 90 x 90	2	6	8
DTK-110-13084	110x110x110	1	4	6

## COUPLING REDUCTION TE

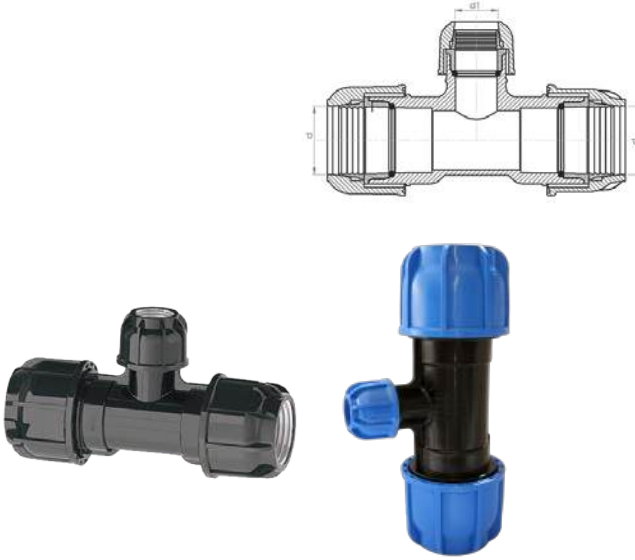

Product Code	Diameter	Packing Quantity		
		Poşet / Bag	Koli/Box	Çuval/Sack
DTK-020-14000	20 x 25 x 20	20	200	240
DTK-025-14004	25 x 20 x 25	20	160	200
DTK-025-14005	25 x 32 x 25	20	120	160
DTK-032-14010	32 x 20 x 32	10	90	120
DTK-032-14011	32 x 25 x 32	10	80	120
DTK-040-14019	40 x 25 x 40	10	80	90
DTK-040-14020	40 x 32 x 40	10	60	90
DTK-050-14029	50 x 25 x 50	4	40	48
DTK-050-14030	50 x 32 x 50	4	40	48
DTK-050-14031	50 x 40 x 50	4	40	48
DTK-063-14041	63 x 25 x 63	4	24	32
DTK-063-14042	63 x 32 x 63	4	24	32
DTK-063-14043	63 x 40 x 63	4	24	32
DTK-063-14044	63 x 50 x 63	4	24	32
DTK-075-14056	75 x 50 x 75	2	10	16
DTK-075-14057	75 x 63 x 75	2	10	16
DTK-090-14073	90 x 63 x 90	2	8	10
DTK-090-14074	90 x 75 x 90	2	8	10
DTK-110-14089	110 x 63 x 110	1	4	6
DTK-110-14091	110 x 90 x 110	1	4	6

## COUPLING SLEEVE



Product Code	Diameter	Packing Quantity		
		Bag	Box	Sack
DTK-020-22000	20 x 20	50	450	600
DTK-025-22004	25 x 25	50	300	350
DTK-032-22010	32 x 32	30	180	240
DTK-040-22018	40 x 40	20	80	140
DTK-050-22028	50 x 50	10	70	90
DTK-063-22040	63 x 63	8	48	56
DTK-075-22052	75 x 75	4	20	28
DTK-090-22068	90 x 90	4	16	20
DTK-110-22084	110 x 110	2	6	10

## COUPLING MALE ELBOW



Product Code	Diameter d x G	Packing Quantity		
		Bag	Box	Sack
DTK-020-19001	20 x 1/2"	50	600	700
DTK-020-19002	20 x 3/4"	50	600	700
DTK-025-19005	25 x 1/2"	30	360	420
DTK-025-19006	25 x 3/4"	30	360	420
DTK-025-19007	25 x 1"	30	360	420
DTK-032-19012	32 x 3/4"	20	180	240
DTK-032-19013	32 x 1"	20	180	240
DTK-032-19014	32 x 1 1/4"	20	180	240
DTK-040-19021	40 x 1"	10	120	140
DTK-040-19022	40 x 1 1/4"	10	120	140
DTK-040-19023	40 x 1 1/2"	10	120	140
DTK-050-19032	50 x 1 1/4"	10	70	100
DTK-050-19033	50 x 1 1/2"	10	70	100
DTK-050-19035	50 x 2"	10	70	100
DTK-063-19045	63 x 1 1/2"	8	48	64
DTK-063-19047	63 x 2"	8	48	64
DTK-063-19049	63 x 2 1/2"	8	48	64
DTK-075-19059	75 x 2"	4	24	32
DTK-075-19061	75 x 2 1/2"	4	24	32
DTK-075-19063	75 x 3"	4	24	32
DTK-090-19077	90 x 2 1/2"	2	14	18
DTK-090-19079	90 x 3"	2	14	18
DTK-090-19083	90 x 4"	2	14	18
DTK-110-19095	110 x 3"	2	8	14
DTK-110-19099	110 x 4"	2	8	14

## COUPLING FEMALE ELBOW



Product Code	Diameter d x G	Packing Quantity		
		Bag	Box	Sack
DTK-020-20001	20 x 1/2"	50	600	700
DTK-020-20002	20 x 3/4"	50	500	700
DTK-025-20005	25 x 1/2"	30	300	420
DTK-025-20006	25 x 3/4"	30	300	420
DTK-025-20007	25 x 1"	30	300	420
DTK-032-20012	32 x 3/4"	20	180	240
DTK-032-20013	32 x 1"	20	180	240
DTK-032-20014	32 x 1 1/4"	20	180	240
DTK-040-20021	40 x 1"	10	120	140
DTK-040-20022	40 x 1 1/4"	10	120	140
DTK-040-20023	40 x 1 1/2"	10	120	140
DTK-050-20032	50 x 1 1/4"	10	70	100
DTK-050-20033	50 x 1 1/2"	10	70	100
DTK-050-20035	50 x 2"	10	70	100
DTK-063-20045	63 x 1 1/2"	8	48	64
DTK-063-20047	63 x 2"	8	48	64
DTK-063-20049	63 x 2 1/2"	8	48	64
DTK-075-20059	75 x 2"	4	24	32
DTK-075-20061	75 x 2 1/2"	4	24	32
DTK-075-20063	75 x 3"	4	24	32
DTK-090-20077	90 x 2 1/2"	2	14	18
DTK-090-20079	90 x 3"	2	14	18
DTK-090-20083	90 x 4"	2	14	18
DTK-110-20095	110 x 3"	2	8	14
DTK-110-20099	110 x 4"	2	8	14

## COUPLING ELBOW



Product Code	Diameter	Packing Quantity		
		Bag	Box	Sack
DTK-020-18000	20 x 20	50	400	600
DTK-025-18004	25 x 25	30	210	270
DTK-032-18010	32 x 32	20	140	180
DTK-040-18018	40 x 40	12	72	108
DTK-050-18028	50 x 50	8	48	64
DTK-063-18040	63 x 63	8	32	48
DTK-075-18052	75 x 75	4	16	24
DTK-090-18068	90 x 90	2	10	16
DTK-110-18084	110 x 110	1	6	10

## COUPLING REDUCTION ELBOW

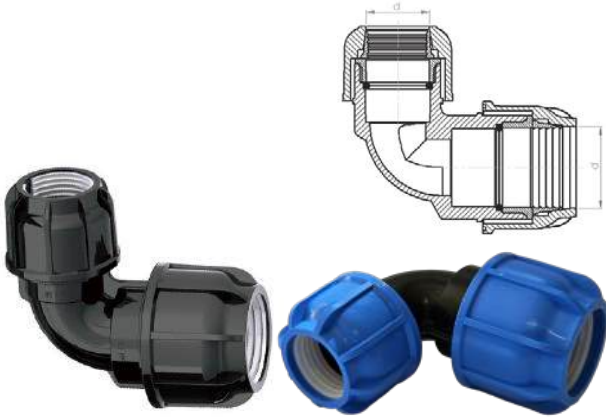

Product Code	Diameter	Packing Quantity		
		Bag	Box	Sack
DTK-025-21004	25 x 20	30	300	360
DTK-032-21011	32 x 25	20	160	200
DTK-040-21020	40 x 32	10	90	120
DTK-050-21031	50 x 40	8	64	80
DTK-063-21044	63 x 50	8	40	56
DTK-075-21057	75 x 63	4	24	32
DTK-090-21074	90 x 75	2	10	16
DTK-110-21091	110 x 90	2	8	12

## COUPLING REDUCTION SLEEVE

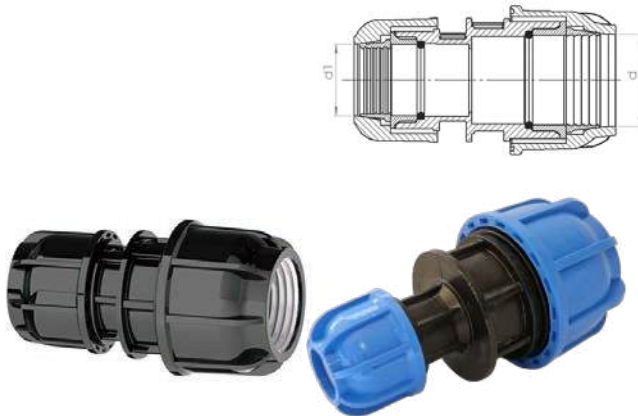

Product Code	Diameter	Packing Quantity		
		Bag	Box	Sack
DTK-025-23004	25 x 20	50	300	400
DTK-032-23010	32 x 20	20	200	240
DTK-032-23011	32 x 25	20	200	240
DTK-040-23018	40 x 20	20	120	180
DTK-040-23019	40 x 25	20	120	180
DTK-040-23020	40 x 32	20	120	180
DTK-050-23029	50 x 25	10	80	90
DTK-050-23030	50 x 32	10	80	90
DTK-050-23031	50 x 40	10	80	90
DTK-063-23041	63 x 25	10	60	70
DTK-063-23042	63 x 32	10	60	70
DTK-063-23043	63 x 40	10	60	70
DTK-063-23044	63 x 50	10	50	70
DTK-075-23056	75 x 50	3	27	36
DTK-075-23057	75 x 63	3	27	36
DTK-090-23073	90 x 63	3	18	24
DTK-090-23074	90 x 75	3	18	24
DTK-110-23089	110 x 63	2	8	14
DTK-110-23090	110 x 75	2	8	14
DTK-110-23091	110 x 90	2	8	14

## COUPLING SHOULDERED ADAPTER

Product Code	Diameter	Packing Quantity		
		Bag	Box	Sack
	d x G			
DTK-063-12047	63 x 2"	12	72	96
DTK-110-12099	110 x 4"	4	12	20

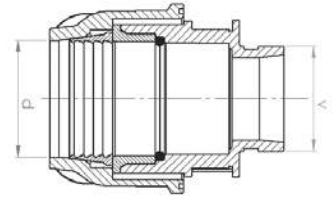

## COUPLING SHOULDERED TE ADAPTER

Product Code	Diameter	Packing Quantity		
		Bag	Box	Sack
	d x G			
DTK-063-17047	63 x 2" x 63	4	24	32
DTK-110-17091	110 x 4" x 110	1	4	8

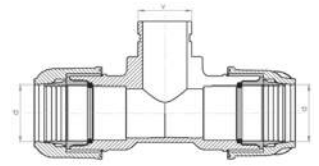

## COUPLING END CAP

Product Code	Diameter	Packing Quantity		
		Bag	Box	Sack
	d x G			
DTK-020-24000	20	100	1.000	1100
DTK-025-24004	25	50	500	600
DTK-032-24010	32	50	300	400
DTK-040-24018	40	30	150	270
DTK-050-24028	50	16	112	144
DTK-063-24040	63	12	72	96
DTK-075-24052	75	6	36	54
DTK-090-24068	90	6	24	36
DTK-110-24084	110	4	12	20

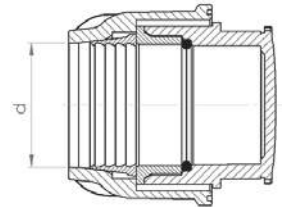

DATKA Clamp Saddles are designed by making improvements for easy usage of the last user while considering the lack in the features of the products available in the market. It provides excellent leakproof by the help of strengthening has been made on its body and o-ring system. In order to ease working in the difficult field conditions Bolt Holder Nail System has been improved to prevent the fall of the bolts when they are in upsidedown position. Tightening bumps have been located on the inside surface for the purpose of fixing the pipe's rotation. Thanks to its gasket system designed in concave form, it prevents any problem may occur due to size differences in pipe diameters up to  $\pm 0.5$  mm or ovality.

• Bolt Holder Nail System and Pipe Fixing Tightening Bumps are only available in single outlet clamp saddles concerning their manufacturing technics. •

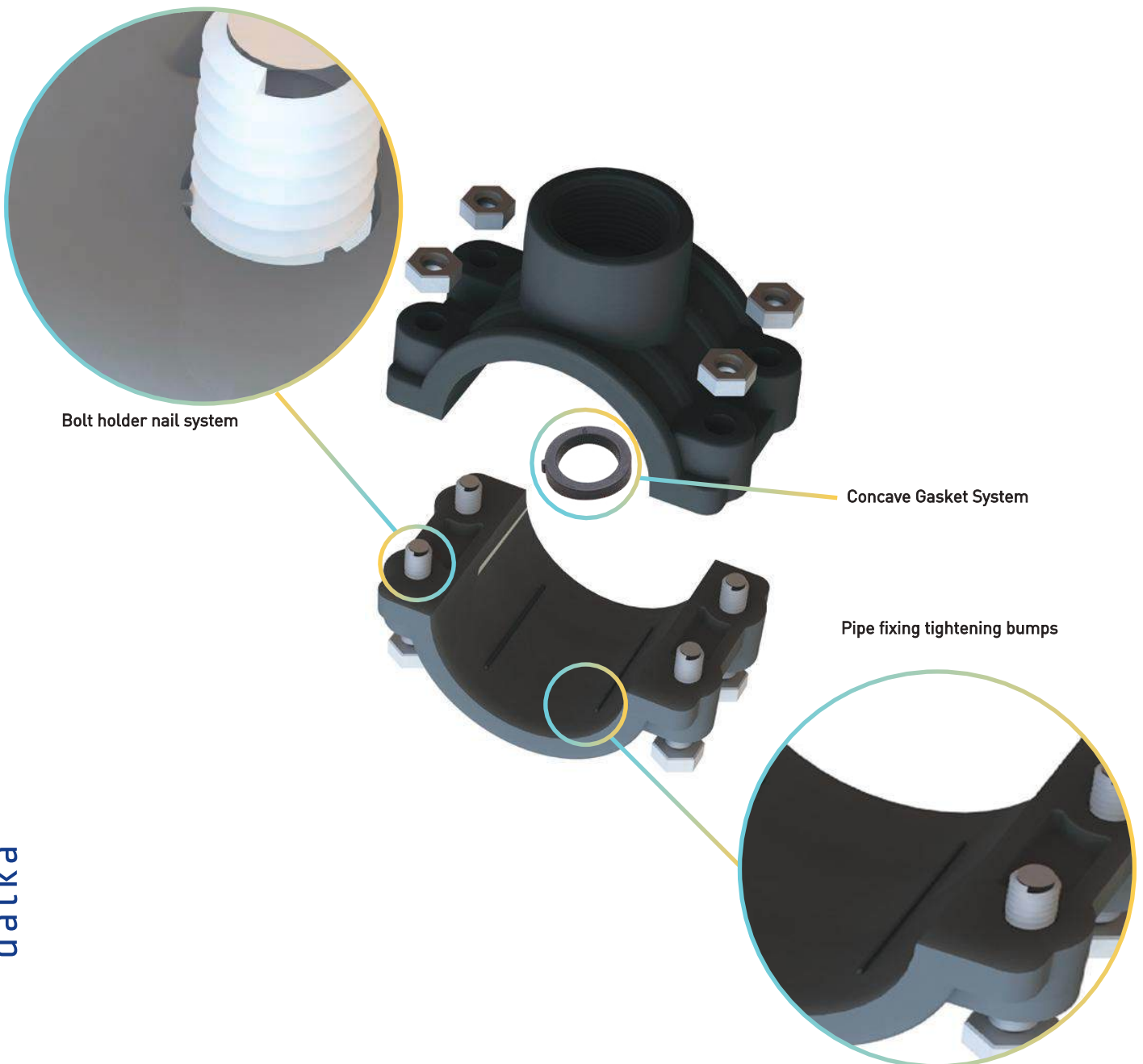

## SINGLE OUTLET CLAMP SADDLE

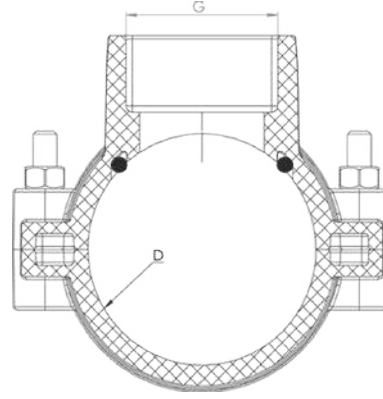

Product Code	Diameter	Packing Quantity	
	d x G	Box	Sack
DTK-025-50005	25 x 1/2"	400	600
DTK-032-50011	32 x 1/2"	350	500
DTK-032-50012	32 x 3/4"	350	500
DTK-040-50019	40 x 1/2"	250	400
DTK-040-50020	40 x 3/4"	250	400
DTK-050-50029	50 x 1/2"	180	200
DTK-050-50030	50 x 3/4"	180	200
DTK-050-50031	50 x 1"	180	200
DTK-063-50041	63 x 1/2"	150	200
DTK-063-50042	63 x 3/4"	150	200
DTK-063-50043	63 x 1"	150	200
DTK-063-50044	63 x 1 1/4"	150	200
DTK-063-50045	63 x 1 1/2"	150	200
DTK-075-50053	75 x 1/2"	100	150
DTK-075-50054	75 x 3/4"	100	150
DTK-075-50055	75 x 1"	100	150
DTK-075-50056	75 x 1 1/4"	100	150
DTK-075-50057	75 x 1 1/2"	100	150
DTK-075-50059	75 x 2"	100	150
DTK-090-50069	90 x 1/2"	75	100
DTK-090-50070	90 x 3/4"	75	100
DTK-090-50071	90 x 1"	75	100
DTK-090-50072	90 x 1 1/4"	75	100
DTK-090-50073	90 x 1 1/2"	75	100
DTK-090-50075	90 x 2"	75	100

Product Code	Diameter	Packing Quantity	
	d x G	Box	Sack
DTK-110-50085	110 x 1/2"	60	100
DTK-110-50086	110 x 3/4"	60	100
DTK-110-50087	110 x 1"	60	100
DTK-110-50088	110 x 1 1/4"	60	100
DTK-110-50089	110 x 1 1/2"	60	100
DTK-110-50091	110 x 2"	60	100
DTK-125-50102	125 x 3/4"	45	75
DTK-125-50103	125 x 1"	45	75
DTK-125-50104	125 x 1 1/4"	45	75
DTK-125-50105	125 x 1 1/2"	45	75
DTK-125-50107	125 x 2"	45	75
DTK-140-50118	140 x 3/4"	40	50
DTK-140-50119	140 x 1"	40	50
DTK-140-50120	140 x 1 1/4"	40	50
DTK-140-50121	140 x 1 1/2"	40	50
DTK-140-50123	140 x 2"	40	50
DTK-160-50134	160 x 3/4"	40	50
DTK-160-50135	160 x 1"	40	50
DTK-160-50136	160 x 1 1/4"	40	50
DTK-160-50137	160 x 1 1/2"	40	50
DTK-160-50139	160 x 2"	40	50
DTK-200-50150	200 x 3/4"	30	40
DTK-200-50151	200 x 1"	30	40
DTK-200-50152	200 x 1 1/4"	30	40
DTK-200-50153	200 x 1 1/2"	30	40
DTK-200-50155	200 x 2"	30	40

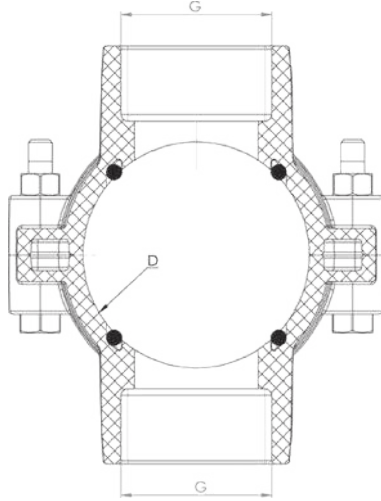

Product Code	Diameter d x G x G	Packing Quantity	
		Box	Sack
DTK-025-55005	25 x 1/2" x 1/2"	400	600
DTK-032-55011	32 x 1/2" x 1/2"	350	500
DTK-032-55012	32 x 3/4" x 3/4"	350	500
DTK-040-55019	40 x 1/2" x 1/2"	250	400
DTK-040-55020	40 x 3/4" x 3/4"	250	400
DTK-050-55029	50 x 1/2" x 1/2"	180	200
DTK-050-55030	50 x 3/4" x 3/4"	180	200
DTK-050-55031	50 x 1" x 1"	180	200
DTK-063-55041	63 x 1/2" x 1/2"	150	200
DTK-063-55042	63 x 3/4" x 3/4"	150	200
DTK-063-55043	63 x 1" x 1"	150	200
DTK-063-55044	63 x 1 1/4" x 1 1/4"	150	200
DTK-063-55045	63 x 1 1/2" x 1 1/2"	150	200
DTK-075-55053	75 x 1/2" x 1/2"	100	150
DTK-075-55054	75 x 3/4" x 3/4"	100	150
DTK-075-55055	75 x 1" x 1"	100	150
DTK-075-55056	75 x 1 1/4" x 1 1/4"	100	150
DTK-075-55057	75 x 1 1/2" x 1 1/2"	100	150
DTK-075-55059	75 x 2" x 2"	100	150
DTK-090-55069	90 x 1/2" x 1/2"	75	100
DTK-090-55070	90 x 3/4" x 3/4"	75	100
DTK-090-55071	90 x 1" x 1"	75	100
DTK-090-55072	90 x 1 1/4" x 1 1/4"	75	100
DTK-090-55073	90 x 1 1/2" x 1 1/2"	75	100
DTK-090-55075	90 x 2" x 2"	75	100

Product Code	Diameter d x G x G	Packing Quantity	
		Box	Sack
DTK-110-55085	110 x 1/2" x 1/2"	60	100
DTK-110-55086	110 x 3/4" x 3/4"	60	100
DTK-110-55087	110 x 1" x 1"	60	100
DTK-110-55088	110 x 1 1/4" x 1 1/4"	60	100
DTK-110-55089	110 x 1 1/2" x 1 1/2"	60	100
DTK-110-55091	110 x 2" x 2"	60	100
DTK-125-55102	125 x 3/4" x 3/4"	45	75
DTK-125-55103	125 x 1" x 1"	45	75
DTK-125-55104	125 x 1 1/4" x 1 1/4"	45	75
DTK-125-55105	125 x 1 1/2" x 1 1/2"	45	75
DTK-125-55107	125 x 2" x 2"	45	75
DTK-140-55118	140 x 3/4" x 3/4"	40	50
DTK-140-55119	140 x 1" x 1"	40	50
DTK-140-55120	140 x 1 1/4" x 1 1/4"	40	50
DTK-140-55121	140 x 1 1/2" x 1 1/2"	40	50
DTK-140-55123	140 x 2" x 2"	40	50
DTK-160-55134	160 x 3/4" x 3/4"	40	50
DTK-160-55135	160 x 1" x 1"	40	50
DTK-160-55136	160 x 1 1/4" x 1 1/4"	40	50
DTK-160-55137	160 x 1 1/2" x 1 1/2"	40	50
DTK-160-55139	160 x 2" x 2"	40	50
DTK-200-55150	200 x 3/4" x 3/4"	30	40
DTK-200-55151	200 x 1" x 1"	30	40
DTK-200-55152	200 x 1 1/4" x 1 1/4"	30	40
DTK-200-55153	200 x 1 1/2" x 1 1/2"	30	40
DTK-200-55155	200 x 2" x 2"	30	40

# VALVE BOX

## Box with Valve 3/4"

CODE	DIMENSIONS (cm)	IN PALLET (Pcs)	UNIT WEIGHT (Kg)
DT3/4	18 x 18 x 12	480	0,771

\*\*Pallet Size  
120 x 130 x 210 cm



## Round Valve Box 6"

CODE	DIMENSIONS (cm)	IN PALLET (Pcs)	UNIT WEIGHT (Kg)
DT6	16,4 x 23,7 x 6	500	0,59

\*\*Pallet Size  
110 x 120 x 180 cm



## Round Valve Box 10"

CODE	DIMENSIONS (cm)	IN PALLET (Pcs)	UNIT WEIGHT (Kg)
DT10	24,6 x 25 x 10	300	1,283

\*\*Pallet Size  
110 x 120 x 200 cm



## Standard Valve Box 12"

CODE	DIMENSIONS (cm)	IN PALLET (Pcs)	UNIT WEIGHT (Kg)
DT12S	26,8 x 39,4 x 30,8	150	3,413

\*\*Pallet Size  
110 x 120 x 200 cm



## Standard Valve Box Locked 12"

CODE	DIMENSIONS (cm)	IN PALLET (Pcs)	UNIT WEIGHT (Kg)
DT12L	26,8 x 39,4 x 30,8	150	3,413

\*\*Pallet Size  
110 x 120 x 200 cm



## Standard Valve Box Hinged 12"

CODE	DIMENSIONS (cm)	IN PALLET (Pcs)	UNIT WEIGHT (Kg)
DT12H	26,8 x 39,4 x 30,8	150	3,413

\*\*Pallet Size  
110 x 120 x 200 cm



## Jumbo Valve Box 14"

CODE	DIMENSIONS (cm)	IN PALLET (Pcs)	UNIT WEIGHT (Kg)
DT14	48 x 63 x 30,5	100	5,5

\*\*Pallet Size  
110 x 120 x 200 cm



# FILTERS

PLASTİK KELEPÇELİ SERİ / PLASTIC CLAMPED SERIES

## İKİZ PLASTİK DİSK FİLTRELER / DOUBLE PLASTIC DISC FILTERS

■ 130 micron / 120 mesh  
Bağlantı Tipi • Connection Type



V: Viktolik • Victaulic

T: Dişli • Threaded  
BSPT | NPT



Bağlantı Çapı Connection Diameter	Ürün Kodu Product Code	Bağlantı Tipi Connection Type	Cinsi Type	Kapasite Capacity	Filtrasyon Yüzeyi Filtration Surface	Koli Tipi Box Type
inch				m <sup>3</sup> /h	cm <sup>2</sup>	
3"	960-030-01-01	BSPT x BSPT	Kısa Short	70	2670	B-4
	960-030-01-11	NPT x NPT				
	960-030-01-02	V x V				
	960-030-02-01	BSPT x BSPT	Uzun Long	100	3615	B-5
	960-030-02-11	NPT x NPT				
	960-030-02-02	V x V				
4"	960-040-01-01	BSPT x BSPT	Kısa Short	70	2670	B-4
	960-040-01-11	NPT x NPT				
	960-040-01-02	V x V				
	960-040-02-01	BSPT x BSPT	Uzun Long	100	3615	B-5
	960-040-02-11	NPT x NPT				
	960-040-02-02	V x V				

## İKİZ PLASTİK ELEK FİLTRELER / DOUBLE PLASTIC SCREEN FILTERS

■ 530 micron / 35 mesh  
■ 200 micron / 75 mesh  
■ 130 micron / 120 mesh  
■ 100 micron / 150 mesh

Bağlantı Tipi • Connection Type



V: Viktolik • Victaulic

T: Dişli • Threaded  
BSPT | NPT



Bağlantı Çapı Connection Diameter	Ürün Kodu Product Code	Bağlantı Tipi Connection Type	Cinsi Type	Kapasite Capacity	Filtrasyon Yüzeyi Filtration Surface	Koli Tipi Box Type
inch				m <sup>3</sup> /h	cm <sup>2</sup>	
3"	960-030-01-03	BSPT x BSPT	Kısa Short	70	2435	B-4
	960-030-01-13	NPT x NPT				
	960-030-01-04	V x V				
	960-030-02-03	BSPT x BSPT	Uzun Long	100	3245	B-5
	960-030-02-13	NPT x NPT				
	960-030-02-04	V x V				
4"	960-040-01-03	BSPT x BSPT	Kısa Short	70	2435	B-4
	960-040-01-13	NPT x NPT				
	960-040-01-04	V x V				
	960-040-02-03	BSPT x BSPT	Uzun Long	100	3245	B-5
	960-040-02-13	NPT x NPT				
	960-040-02-04	V x V				

Filtre kelepçeleri mühendislik plastiğinden üretilmiştir.  
Filter clamps are produced of engineering plastic.

TEKLİ PLASTİK DİSK FİLTRELER /  
SINGLE PLASTIC DISC FILTERS130 micron / 120 mesh  
Bağlantı Tipi • Connection Type

V: Viktolik • Victaulic

T: Dişli • Threaded  
BSPT | NPT

Bağlantı Çapı Connection Diameter	Ürün Kodu Product Code	Bağlantı Tipi Connection Type	Cinsi Type	Kapasite Capacity	Filtrasyon Yüzeyi Filtration Surface	Koli Tipi Box Type	
inch				m <sup>3</sup> /h	cm <sup>2</sup>		
2"	910-020-01-01	BSPT x BSPT x BSPT	Kısa Short	40	1335	B-3	
	910-020-01-11	NPT x NPT x NPT					
	910-020-01-02	V x V x BSPT					
	910-020-01-12	V x V x NPT					
	910-020-01-03	V x BSPT x V					
	910-020-01-13	V x NPT x V					
	910-020-02-01	BSPT x BSPT x BSPT	Uzun Long	40	1810	B-3	
	910-020-02-11	NPT x NPT x NPT					
	910-020-02-02	V x V x BSPT					
	910-020-02-12	V x V x NPT					
	910-020-02-03	V x BSPT x V					
	910-020-02-13	V x NPT x V					
	2 ½"	910-025-01-01	BSPT x BSPT x BSPT	Kısa Short	48	1335	B-3
		910-025-01-11	NPT x NPT x NPT				
910-025-01-02		V x V x BSPT					
910-025-01-12		V x V x NPT					
910-025-01-03		V x BSPT x V					
910-025-01-13		V x NPT x V					
910-025-02-01		BSPT x BSPT x BSPT	Uzun Long	48	1810	B-3	
910-025-02-11		NPT x NPT x NPT					
910-025-02-02		V x V x BSPT					
910-025-02-12		V x V x NPT					
910-025-02-03		V x BSPT x V					
910-025-02-13		V x NPT x V					
3"		910-030-01-01	BSPT x BSPT x BSPT	Kısa Short	55	1335	B-3
		910-030-01-11	NPT x NPT x NPT				
	910-030-01-02	V x V x BSPT					
	910-030-01-12	V x V x NPT					
	910-030-01-03	V x BSPT x V					
	910-030-01-13	V x NPT x V					
	910-030-02-01	BSPT x BSPT x BSPT	Uzun Long	55	1810	B-3	
	910-030-02-11	NPT x NPT x NPT					
	910-030-02-02	V x V x BSPT					
	910-030-02-12	V x V x NPT					
	910-030-02-03	V x BSPT x V					
	910-030-02-13	V x NPT x V					

Filtre kelepçeleri mühendislik plastiğinden üretilmiştir.  
Filter clamps are produced of engineering plastic.

TEKLİ PLASTİK ELEK FİLTRELER /  
SINGLE PLASTIC SCREEN FILTERS

■ 530 micron / 35 mesh      130 micron / 120 mesh ■  
■ 200 micron / 75 mesh      100 micron / 150 mesh ■

Bağlantı Tipi • Connection Type

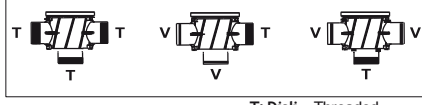

V: Viktolik • Victaulic

T: Dişli • Threaded  
BSPT | NPT

Bağlantı Çapı Connection Diameter	Ürün Kodu Product Code	Bağlantı Tipi Connection Type	Cinsi Type	Kapasite Capacity	Filtrasyon Yüzeyi Filtration Surface	Koli Tipi Box Type
inch				m <sup>3</sup> /h	cm <sup>2</sup>	
2"	910-020-01-04	BSPT x BSPT x BSPT	Kısa Short	40	1210	B-3
	910-020-01-14	NPT x NPT x NPT				
	910-020-01-05	V x V x BSPT				
	910-020-01-15	V x V x NPT				
	910-020-01-06	V x BSPT x V				
	910-020-01-16	V x NPT x V				
	910-020-02-04	BSPT x BSPT x BSPT	Uzun Long	40	1620	B-3
	910-020-02-14	NPT x NPT x NPT				
	910-020-02-05	V x V x BSPT				
	910-020-02-15	V x V x NPT				
	910-020-02-06	V x BSPT x V				
	910-020-02-16	V x NPT x V				
2 ½"	910-025-01-04	BSPT x BSPT x BSPT	Kısa Short	48	1210	B-3
	910-025-01-14	NPT x NPT x NPT				
	910-025-01-05	V x V x BSPT				
	910-025-01-15	V x V x NPT				
	910-025-01-06	V x BSPT x V				
	910-025-01-16	V x NPT x V				
	910-025-02-04	BSPT x BSPT x BSPT	Uzun Long	48	1620	B-3
	910-025-02-14	NPT x NPT x NPT				
	910-025-02-05	V x V x BSPT				
	910-025-02-15	V x V x NPT				
	910-025-02-06	V x BSPT x V				
	910-025-02-16	V x NPT x V				
3"	910-030-01-04	BSPT x BSPT x BSPT	Kısa Short	55	1210	B-3
	910-030-01-14	NPT x NPT x NPT				
	910-030-01-05	V x V x BSPT				
	910-030-01-15	V x V x NPT				
	910-030-01-06	V x BSPT x V				
	910-030-01-16	V x NPT x V				
	910-030-02-04	BSPT x BSPT x BSPT	Uzun Long	55	1620	B-3
	910-030-02-14	NPT x NPT x NPT				
	910-030-02-05	V x V x BSPT				
	910-030-02-15	V x V x NPT				
	910-030-02-06	V x BSPT x V				
	910-030-02-16	V x NPT x V				

Filtre kelepçeleri mühendislik plastiğinden üretilmiştir.  
Filter clamps are produced of engineering plastic.

İKİZ PLASTİK DİSK FİLTRELER /  
DOUBLE PLASTIC DISC FILTERS130 micron / 120 mesh ■  
Bağlantı Tipi • Connection Type

V: Viktolik • Victaulic

T: Dişli • Threaded  
BSPT | NPT

Bağlantı Çapı Connection Diameter	Ürün Kodu Product Code	Bağlantı Tipi Connection Type	Cinsi Type	Kapasite Capacity	Filtrasyon Yüzeyi Filtration Surface	Koli Tipi Box Type
inch				m <sup>3</sup> /h	cm <sup>2</sup>	
3"	950-030-01-01	BSPT x BSPT	Kısa Short	70	2670	B-4
	950-030-01-11	NPT x NPT				
	950-030-01-02	V x V				
	950-030-02-01	BSPT x BSPT	Uzun Long	100	3615	B-5
	950-030-02-11	NPT x NPT				
	950-030-02-02	V x V				
4"	950-040-01-01	BSPT x BSPT	Kısa Short	70	2670	B-4
	950-040-01-11	NPT x NPT				
	950-040-01-02	V x V				
	950-040-02-01	BSPT x BSPT	Uzun Long	100	3615	B-5
	950-040-02-11	NPT x NPT				
	950-040-02-02	V x V				

İKİZ PLASTİK ELEK FİLTRELER /  
DOUBLE PLASTIC SCREEN FILTERS

■ 530 micron / 35 mesh      ■ 130 micron / 120 mesh  
■ 200 micron / 75 mesh      ■ 100 micron / 150 mesh

Bağlantı Tipi • Connection Type



V: Viktolik • Victaulic

T: Dişli • Threaded  
BSPT | NPT

Bağlantı Çapı Connection Diameter	Ürün Kodu Product Code	Bağlantı Tipi Connection Type	Cinsi Type	Kapasite Capacity	Filtrasyon Yüzeyi Filtration Surface	Koli Tipi Box Type
inch				m <sup>3</sup> /h	cm <sup>2</sup>	
3"	950-030-01-03	BSPT x BSPT	Kısa Short	70	2435	B-4
	950-030-01-13	NPT x NPT				
	950-030-01-04	V x V				
	950-030-02-03	BSPT x BSPT	Uzun Long	100	3245	B-5
	950-030-02-13	NPT x NPT				
	950-030-02-04	V x V				
4"	950-040-01-03	BSPT x BSPT	Kısa Short	70	2435	B-4
	950-040-01-13	NPT x NPT				
	950-040-01-04	V x V				
	950-040-02-03	BSPT x BSPT	Uzun Long	100	3245	B-5
	950-040-02-13	NPT x NPT				
	950-040-02-04	V x V				

Filtre kelepçeleri paslanmaz çelikten üretilmiştir.  
Filter clamps are produced of stainless steel.

TEKLİ PLASTİK DİSK FİLTRELER /  
SINGLE PLASTIC DISC FILTERS

■ 130 micron / 120 mesh  
Bağlantı Tipi • Connection Type

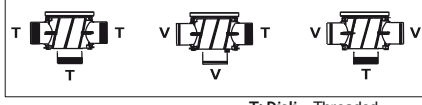

V: Viktolik • Victaulic

T: Dişli • Threaded  
BSPT | NPT



Bağlantı Çapı Connection Diameter	Ürün Kodu Product Code	Bağlantı Tipi Connection Type	Cinsi Type	Kapasite Capacity	Filtrasyon Yüzeği Filtration Surface	Koli Tipi Box Type	
inch				m <sup>3</sup> /h	cm <sup>2</sup>		
2"	900-020-01-01	BSPT x BSPT x BSPT	Kısa Short	40	1335	B-3	
	900-020-01-11	NPT x NPT x NPT					
	900-020-01-02	V x V x BSPT					
	900-020-01-12	V x V x NPT					
	900-020-01-03	V x BSPT x V					
	900-020-01-13	V x NPT x V					
	900-020-02-01	BSPT x BSPT x BSPT	Uzun Long	40	1810	B-3	
	900-020-02-11	NPT x NPT x NPT					
	900-020-02-02	V x V x BSPT					
	900-020-02-12	V x V x NPT					
	900-020-02-03	V x BSPT x V					
	900-020-02-13	V x NPT x V					
	2 ½"	900-025-01-01	BSPT x BSPT x BSPT	Kısa Short	48	1335	B-3
		900-025-01-11	NPT x NPT x NPT				
900-025-01-02		V x V x BSPT					
900-025-01-12		V x V x NPT					
900-025-01-03		V x BSPT x V					
900-025-01-13		V x NPT x V					
900-025-02-01		BSPT x BSPT x BSPT	Uzun Long	48	1810	B-3	
900-025-02-11		NPT x NPT x NPT					
900-025-02-02		V x V x BSPT					
900-025-02-12		V x V x NPT					
900-025-02-03		V x BSPT x V					
900-025-02-13		V x NPT x V					
3"		900-030-01-01	BSPT x BSPT x BSPT	Kısa Short	55	1335	B-3
		900-030-01-11	NPT x NPT x NPT				
	900-030-01-02	V x V x BSPT					
	900-030-01-12	V x V x NPT					
	900-030-01-03	V x BSPT x V					
	900-030-01-13	V x NPT x V					
	900-030-02-01	BSPT x BSPT x BSPT	Uzun Long	55	1810	B-3	
	900-030-02-11	NPT x NPT x NPT					
	900-030-02-02	V x V x BSPT					
	900-030-02-12	V x V x NPT					
	900-030-02-03	V x BSPT x V					
	900-030-02-13	V x NPT x V					

Filtre kelepçeleri paslanmaz çelikten üretilmiştir.  
Filter clamps are produced of stainless steel.

TEKLİ PLASTİK ELEK FİLTRELER /  
SINGLE PLASTIC SCREEN FILTERS

■ 530 micron / 35 mesh      130 micron / 120 mesh ■  
■ 200 micron / 75 mesh      100 micron / 150 mesh ■

Bağlantı Tipi • Connection Type

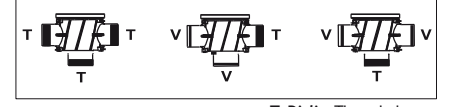

V: Viktolik • Victaulic

T: Dişli • Threaded  
BSPT | NPT

Bağlantı Çapı Connection Diameter	Ürün Kodu Product Code	Bağlantı Tipi Connection Type	Cinsi Type	Kapasite Capacity	Filtrasyon Yüzeyi Filtration Surface	Koli Tipi Box Type
inch				m <sup>3</sup> /h	cm <sup>2</sup>	
2"	900-020-01-04	BSPT x BSPT x BSPT	Kısa Short	40	1210	B-3
	900-020-01-14	NPT x NPT x NPT				
	900-020-01-05	V x V x BSPT				
	900-020-01-15	V x V x NPT				
	900-020-01-06	V x BSPT x V				
	900-020-01-16	V x NPT x V				
	900-020-02-04	BSPT x BSPT x BSPT	Uzun Long	40	1620	B-3
	900-020-02-14	NPT x NPT x NPT				
	900-020-02-05	V x V x BSPT				
	900-020-02-15	V x V x NPT				
	900-020-02-06	V x BSPT x V				
	900-020-02-16	V x NPT x V				
2 ½"	900-025-01-04	BSPT x BSPT x BSPT	Kısa Short	48	1210	B-3
	900-025-01-14	NPT x NPT x NPT				
	900-025-01-05	V x V x BSPT				
	900-025-01-15	V x V x NPT				
	900-025-01-06	V x BSPT x V				
	900-025-01-16	V x NPT x V				
	900-025-02-04	BSPT x BSPT x BSPT	Uzun Long	48	1620	B-3
	900-025-02-14	NPT x NPT x NPT				
	900-025-02-05	V x V x BSPT				
	900-025-02-15	V x V x NPT				
	900-025-02-06	V x BSPT x V				
	900-025-02-16	V x NPT x V				
3"	900-030-01-04	BSPT x BSPT x BSPT	Kısa Short	55	1210	B-3
	900-030-01-14	NPT x NPT x NPT				
	900-030-01-05	V x V x BSPT				
	900-030-01-15	V x V x NPT				
	900-030-01-06	V x BSPT x V				
	900-030-01-16	V x NPT x V				
	900-030-02-04	BSPT x BSPT x BSPT	Uzun Long	55	1620	B-3
	900-030-02-14	NPT x NPT x NPT				
	900-030-02-05	V x V x BSPT				
	900-030-02-15	V x V x NPT				
	900-030-02-06	V x BSPT x V				
	900-030-02-16	V x NPT x V				

Filtre kelepçeleri paslanmaz çelikten üretilmiştir.  
Filter clamps are produced of stainless steel.

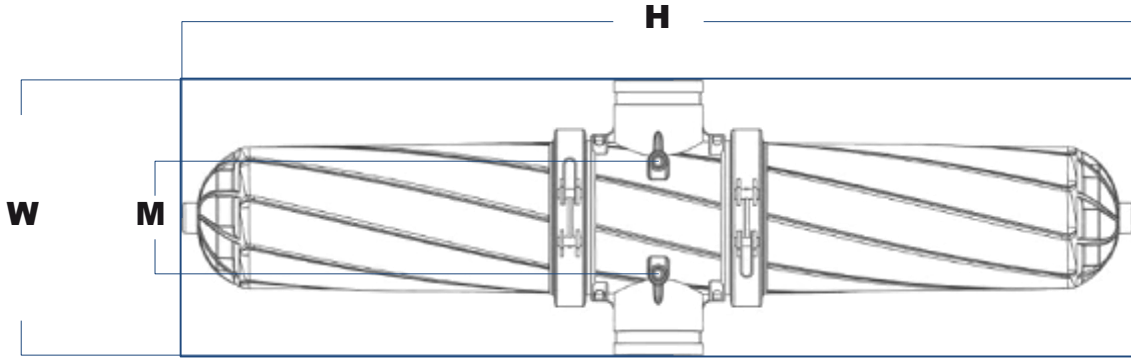

Bağlantı Çapı Connection Diameter	Cinsi Type	W	H	M
inch		mm	mm	mm
3"	Kısa - Short	340	960	140
	Uzun - Long		1200	
4"	Kısa - Short	340	960	140
	Uzun - Long		1200	

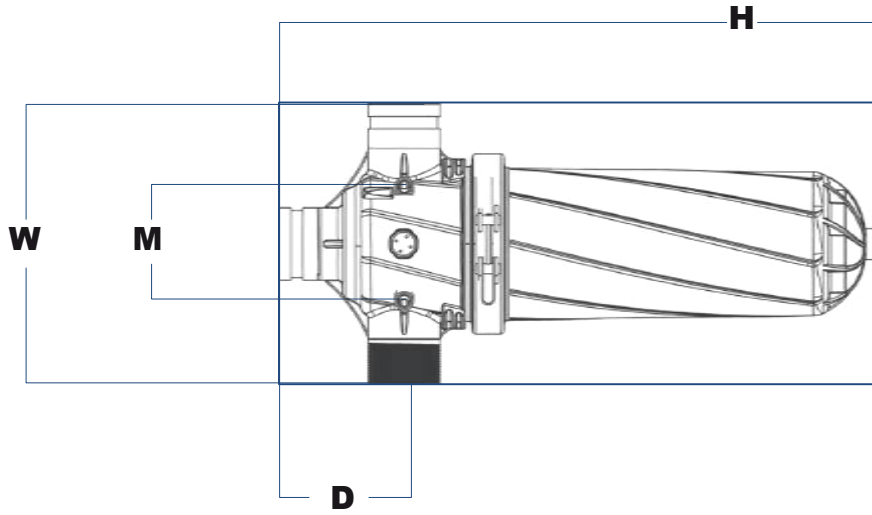

Bağlantı Çapı Connection Diameter	Cinsi Type	W	H	M	D
inch		mm	mm	mm	mm
2"	Kısa - Short	340	630	140	160
	Uzun - Long		740		
2 ½"	Kısa - Short	340	630	140	160
	Uzun - Long		740		
3"	Kısa - Short	340	630	140	160
	Uzun - Long		740		

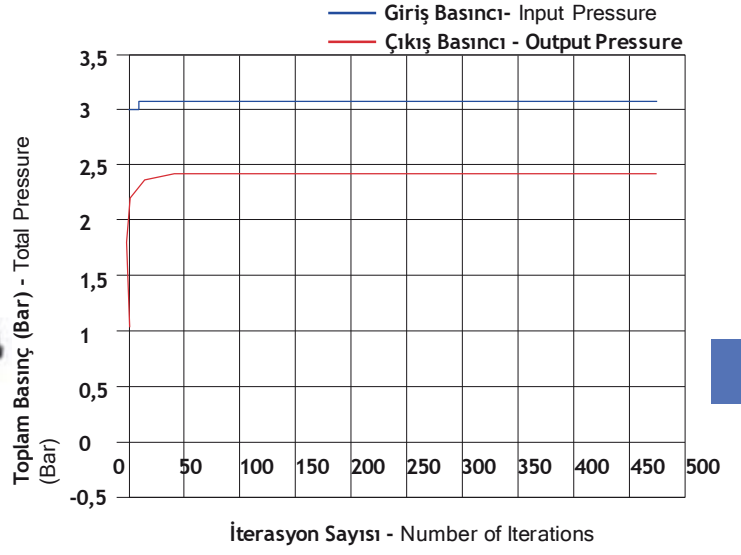

### PLASTİK DİSK FİLTRELER BASINÇ KAYBI

Plastic Disc Filters Head Loss

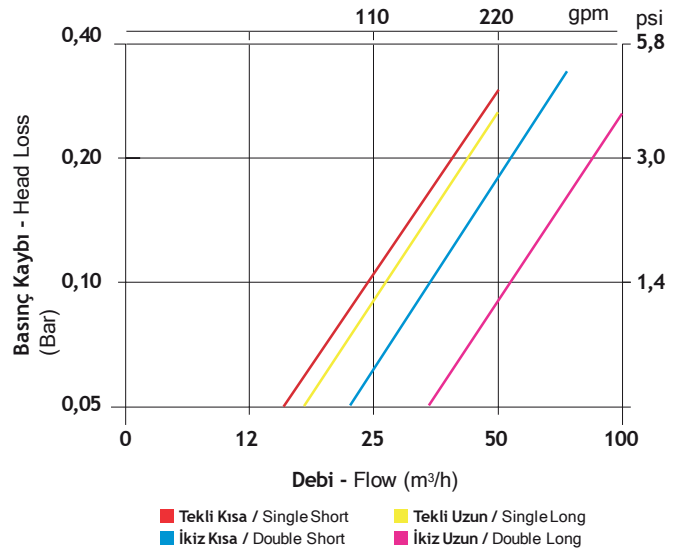

### PLASTİK ELEK FİLTRELER BASINÇ KAYBI

Plastic Screen Filters Head Loss

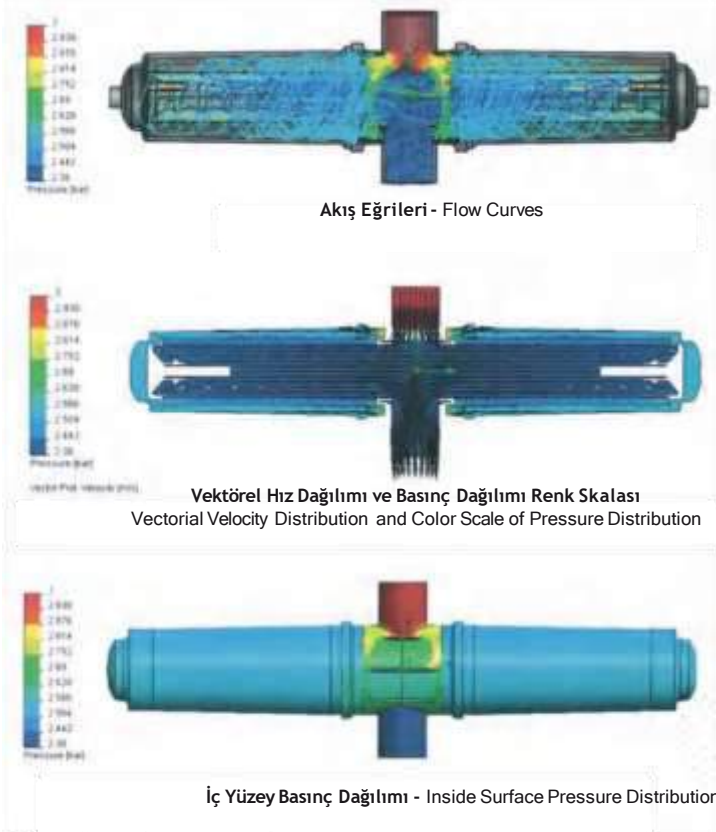
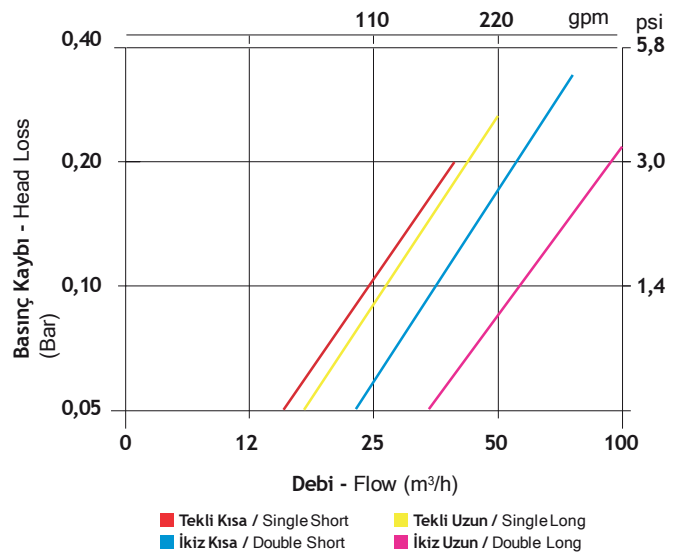

## TEKNİK DETAYLAR/ TECHNICAL SPECS

Gövde - Body	Cam elyaf katkılı poliamid - Fiberglass reinforced polyamide
İç Takım - Cartridge	PP Disk - PP Disc Paslanmaz çelik elek - Stainless steel screen
Kelepçe - Clamp	Mühendislik Plastiği - Engineering Plastic Paslanmaz çelik - Stainless steel
Contalar - O-rings	Kauçuk - Rubber

- ✓ Verilen sonuçlar 130 mikron disk ve elek iç takımlar içindir. pH>4 | Maksimum sıcaklık 60 C | Maksimum basınç 10 Bar
- ✓ Given results are for 130 micron disc and screen cartridges. pH>4 | Maximum temperature 60 C | Maximum pressure 10 Bar

## Y TİP DİSK FİLTRELER / Y TYPE DISC FILTERS

+plus



T: Dişli • Threaded  
BSPT | NPT

■ 130 micron / 120 mesh

Bağlantı Çapı Connection Diameter	Ürün Kodu Product Code	Bağlantı Tipi Connection Type	Kapasite Capacity	Filtrasyon Yüzeği Filtration Surface	Ambalaj Miktarı Packing Quantity		Koli Tipi Box Type
inch			m <sup>3</sup> /h	cm <sup>2</sup>	Poşet / Bag	Koli / Box	
1 ½"	800-112-01-01	BSPT x BSPT	20	559,20	1	15	B-2
	800-112-01-11						
2"	800-200-01-01	BSPT x BSPT	25	559,20	1	15	B-2
	800-200-01-11	NPT x NPT					

## Y TİP DİSK FİLTRELER / Y TYPE DISC FILTERS

midi



T: Dişli • Threaded  
BSPT | NPT

■ 130 micron / 120 mesh

Bağlantı Çapı Connection Diameter	Ürün Kodu Product Code	Bağlantı Tipi Connection Type	Kapasite Capacity	Filtrasyon Yüzeği Filtration Surface	Ambalaj Miktarı Packing Quantity		Koli Tipi Box Type
inch			m <sup>3</sup> /h	cm <sup>2</sup>	Poşet / Bag	Koli / Box	
1 ¼"	800-114-02-01	BSPT x BSPT	10	311,96	1	32	B-2
	800-114-02-11	NPT x NPT					
1 ½"	800-112-02-01	BSPT x BSPT	15	311,96	1	32	B-2
	800-112-02-11	NPT x NPT					

## Y TİP DİSK FİLTRELER / Y TYPE DISC FILTERS

mini



T: Dişli • Threaded  
BSPT | NPT

■ 130 micron / 120 mesh

Bağlantı Çapı Connection Diameter	Ürün Kodu Product Code	Bağlantı Tipi Connection Type	Kapasite Capacity	Filtrasyon Yüzeği Filtration Surface	Ambalaj Miktarı Packing Quantity		Koli Tipi Box Type
inch			m <sup>3</sup> /h	cm <sup>2</sup>	Poşet / Bag	Koli / Box	
¾"	800-034-03-01	BSPT x BSPT	6	172,25	1	60	B-2
	800-034-03-11						
1"	800-100-03-01	BSPT x BSPT	7	172,25	1	60	B-2
	800-100-03-11	NPT x NPT					

## Y TİP ELEK FİLTRELER / Y TYPE SCREEN FILTERS

+plus



T: Dişli • Threaded  
BSPT | NPT

■ 530 micron / 35 mesh    130 micron / 120 mesh ■  
■ 200 micron / 75 mesh    100 micron / 150 mesh ■

Bağlantı Çapı Connection Diameter	Ürün Kodu Product Code	Bağlantı Tipi Connection Type	Kapasite Capacity	Filtrasyon Yüzeği Filtration Surface	Ambalaj Miktarı Packing Quantity		Koli Tipi Box Type
inch			m <sup>3</sup> /h	cm <sup>2</sup>	Poşet / Bag	Koli / Box	
1 ½"	800-112-01-02	BSPT x BSPT	20	525,43	1	15	B-2
	800-112-01-12						
2"	800-200-01-02	BSPT x BSPT	25	525,43	1	15	B-2
	800-200-01-12	NPT x NPT					

## Y TİP ELEK FİLTRELER / Y TYPE SCREEN FILTERS

midi



T: Dişli • Threaded  
BSPT | NPT

■ 530 micron / 35 mesh    130 micron / 120 mesh ■  
■ 200 micron / 75 mesh    100 micron / 150 mesh ■

Bağlantı Çapı Connection Diameter	Ürün Kodu Product Code	Bağlantı Tipi Connection Type	Kapasite Capacity	Filtrasyon Yüzeği Filtration Surface	Ambalaj Miktarı Packing Quantity		Koli Tipi Box Type
inch			m <sup>3</sup> /h	cm <sup>2</sup>	Poşet / Bag	Koli / Box	
1 ¼"	800-114-02-02	BSPT x BSPT	10	322,54	1	32	B-2
	800-114-02-12						
1 ½"	800-112-02-02	BSPT x BSPT	15	322,54	1	32	B-2
	800-112-02-12	NPT x NPT					

## Y TİP ELEK FİLTRELER / Y TYPE SCREEN FILTERS

mini



T: Dişli • Threaded  
BSPT | NPT

■ 530 micron / 35 mesh    130 micron / 120 mesh ■  
■ 200 micron / 75 mesh    100 micron / 150 mesh ■

Bağlantı Çapı Connection Diameter	Ürün Kodu Product Code	Bağlantı Tipi Connection Type	Kapasite Capacity	Filtrasyon Yüzeği Filtration Surface	Ambalaj Miktarı Packing Quantity		Koli Tipi Box Type
inch			m <sup>3</sup> /h	cm <sup>2</sup>	Poşet / Bag	Koli / Box	
¾"	800-034-03-02	BSPT x BSPT	6	178,47	1	60	B-2
	800-034-03-12						
1"	800-100-03-02	BSPT x BSPT	7	178,47	1	60	B-2
	800-100-03-12	NPT x NPT					

## Y TİP DİSK FİLTRELER / Y TYPE DISC FILTERS

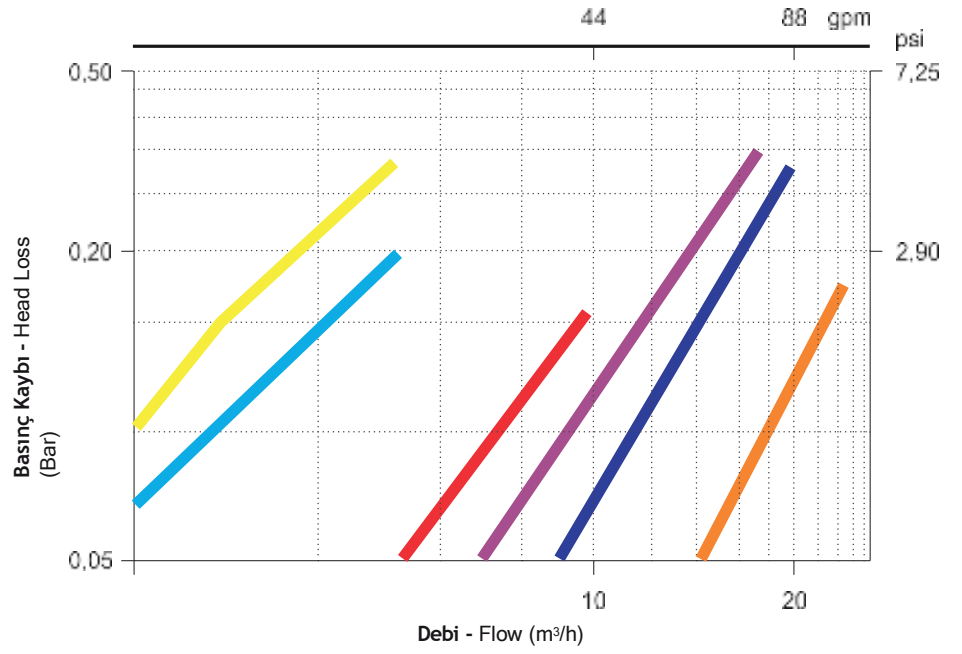
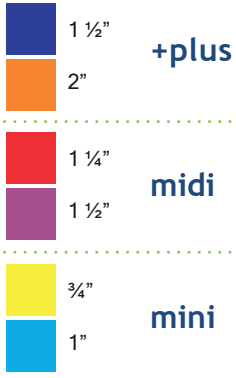

## Y TİP ELEK FİLTRELER / Y TYPE SCREEN FILTERS

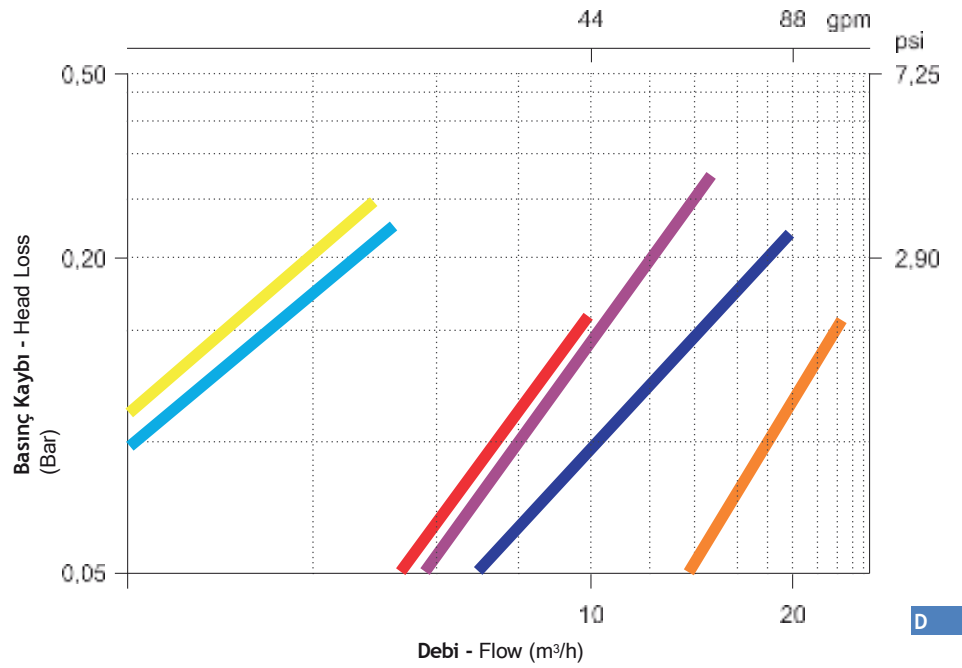
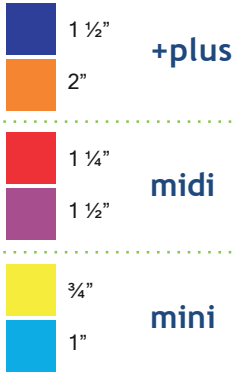

## TEKNİK DETAYLAR/ TECHNICAL SPECS

Gövde - Body	Polipropilen - Polypropylene
İç Takım - Cartridge	PP Disk - PP Disc Paslanmaz çelik elek - Stainless steel screen
Contalar - O rings	Kauçuk - Rubber

Verilen sonuçlar 130 mikron disk ve elek iç takımlar içindir.  
pH>4 | Maksimum sıcaklık 60 C | Maksimum basınç 10 Bar  
Given results are for 130 micron disc and screen cartridges.  
pH>4 | Maximum temperature 60 C | Maximum pressure 10 Bar

## ÖLÇÜLER / DIMENSIONS

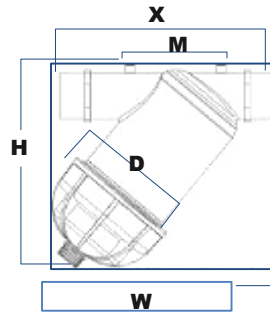

Cinsi Type	Bağlantı Çapı Connection Diameter	X W M H				
		mm	mm	mm	mm	mm
+plus	1 1/2" x 1 1/2"	263	275	110	250	143
	2" x 2"					
midi	1 1/4" x 1 1/4"	230	225	95	205	115
	1 1/2" x 1 1/2"					
mini	3/4" x 3/4"	170	182	70	170	93,5
	1" x 1"					

## PLASTİK FİLTRE İÇ TAKIM DİSK / DISC CARTRIDGE FOR PLASTIC FILTER

130 micron / 120 mesh ■

Ürün Kodu Product Code	Ürün Ölçüleri Product Dimensions	Ambalaj Miktarı Packing Quantity	Koli Tipi Box Type
Tip / Type		Koli/Box	
999-234-00-02	2"-2½"-3"-4" Uzun	8	B-2



## FİLTRE İÇ TAKIM ELEK / SCREEN CARTRIDGE

■ 530 micron / 35 mesh    130 micron / 120 mesh ■  
■ 200 micron / 75 mesh    100 micron / 150 mesh ■

Ürün Kodu Product Code	Ürün Ölçüleri Product Dimensions	Ambalaj Miktarı Packing Quantity	Koli Tipi Box Type
Tip / Type		Koli/Box	
997-025-00-01	25	28	B-2
997-030-00-01	37,5	16	B-2
997-040-00-01	50	12	B-2



## METAL FİLTRE İÇ TAKIM DİSK / DISC CARTRIDGE FOR METAL FILTER

130 micron / 120 mesh ■

Ürün Kodu Product Code	Ürün Ölçüleri Product Dimensions	Ambalaj Miktarı Packing Quantity	Koli Tipi Box Type
Tip / Type		Koli/Box	
998-025-35-01	35	12	B-2
998-030-40-01	40	12	B-2
998-040-50-01	50	8	B-2
998-050-60-01	60	8	B-2



## Y TİPİ FİLTRE İÇ TAKIM DİSK / DISC CARTRIDGE FOR Y TYPE FILTER

130 micron / 120 mesh ■

Ürün Kodu Product Code	Açıklama Explanation	Ambalaj Miktarı Packing Quantity	Koli Tipi Box Type
		Koli/Box	
899-200-02-01	midi	54	B-1
899-300-03-01	mini	112	B-1



## Y TİPİ FİLTRE İÇ TAKIM ELEK / SCREEN CARTRIDGE FOR Y TYPE FILTER

■ 530 micron / 35 mesh    130 micron / 120 mesh ■  
■ 200 micron / 75 mesh    100 micron / 150 mesh ■

Ürün Kodu Product Code	Açıklama Explanation	Ambalaj Miktarı Packing Quantity	Koli Tipi Box Type
		Koli/Box	
897-100-01-02	+plus	28	B-1
897-200-02-02	midi	54	B-1
897-300-03-02	mini	112	B-1



# SPRINKLERS



## A-10 SPRINKLERS

Ürün Kodu	Nozul	(Ømm)	Ambalaj
Product Code	Nozzles	(Ømm)	Packaging
TS 15001 002	2	1/2	125



### DENEY RAPORU EXPERIMENT REPORT

NOZUL NOZZLE	UYGULA MA BASINCI APPLICATIO N PRESSURE (bar)	BAŞLIK DEBİSİ HEADER FLOW (m³/h)	3 TUR SÜRESİ 3 LAP TIME (s)	ISLATMA YARI ÇAPI WETTING RADIUS (m)
3,2 MM SİYAH 1,5 MM MAVİ 3,2 MM BLACK 1,5 MM BLUE	1,5	0,70	27	8,5
	2	0,85	24	9
	3	1,00	22	10
3,2 MM SİYAH 2,8 MM MOR 3,2 MM BLACK 2,8 MM PURPLE	1,5	0,70	27	8,5
	2	0,85	24	9
	3	1,00	22	10
3,2 MM SİYAH 2,1 MM BEYAZ 3,2 MM BLACK 2,1 MM WHITE	1,5	0,70	27	8,5
	2	0,85	24	9
	3	1,00	22	10





# A-30 SPRINKLERS

Ürün Kodu	Nozul	(Ømm)	Ambalaj
Product Code	Nozzles	(Ømm)	Packaging
TS15001 004	2	3/4	50



## DENEY RAPORU EXPERIMENT REPORT

NOZUL NOZZLE	UYGULAMA BASINCI APPLICATION PRESSURE (bar)	BAŞLIK DEBİSİ HEADER FLOW (m <sup>3</sup> /h)	3TUR SÜRESİ 3 LAP TIME (s)	ISLATMA YARI ÇAPI WETTING RADIUS (m)
4,8 MM SİYAH 4,2 MM MOR 4,8 MM BLACK 4,2 MM PURPLE	1,5	1,70	30	11
	2	1,95	31	12
	3	2,20	30	12,5
4,8 MM SİYAH 3,8 MM TURUNCU 4,8 MM BLACK 3,8 MM ORANGE	1,5	1,40	29	11
	2	1,60	28	11,5
	3	2,00	30	12
4,8 MM SİYAH 2,5 MM BEYAZ 4,8 MM BLACK 2,5 MM WHITE	1,5	1,25	32	10
	2	1,50	31	11
	3	1,80	31	11,5
4,2 MM MOR 3,8 MM TURUNCU 4,2 MM PURPLE 3,8 MM ORANGE	1,5	1,25	29	11
	2	1,45	29	12
	3	1,85	35	12
4,2 MM MOR 2,5 MM BEYAZ 4,2 MM PURPLE 2,5 MM WHITE	1,5	1,15	32	10
	2	1,35	35	11
	3	1,70	29	12



# DAMLA SULAMA EKİPMANLARI / DRIP IRRIGATION ACCESSORIES



Küresel Mini Vana

Mini Ball Valve

Kod Code	Ebat Size	Açıklama Description	Adet In Package
361	Ø 16x16		100
362	Ø 20x20		
351	Ø 25x25		
354	Ø 20x16	Reduced	
346	Ø 25x20	Reduced	



Küresel Vana Çıkış Nipelili

Mini Ball Valve Dovetail - Exit

Kod Code	Ebat Size	Adet In Package
363	Ø 16x17	100
355	Ø 20x19	
348	Ø 25x19	



Küresel Mini Vana

Mini Ball Valve Dovetail - Thread

Kod Code	Ebat Size	Adet In Package
364	Ø 16x1/2	100
365	Ø 16x3/4	
366	Ø 20x1/2	
367	Ø 20x3/4	
360	Ø 25x3/4	
350	Ø 3/4x3/4	
352	Ø 1/2x1/2	

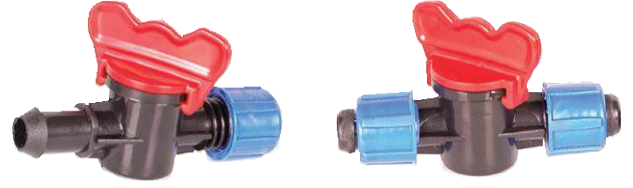

Küresel Yassı Vidalı Boru Vanası

Mini Ball Valve Flat - Exit

Kod Code	Ebat Size	Açıklama Description	Adet In Package
358	Ø 17x17		100
356	Ø 16x17	Exit Nipple	
357	Ø 16x17	Barbed	
359	Ø 17x1/2		



Küresel Mini Vana

Mini Ball Valve Dovetail

Kod Code	Ebat Size	Adet In Package
251	Ø 16x16	100
230	Ø 20x20	



Küresel Vana Çıkış Nipelili

Mini Ball Valve Dovetail - Exit

Kod Code	Ebat Size	Adet In Package
252	Ø 16x17	100
231	Ø 20x19	



Küresel Mini Vana/ Mini Ball Valve

Mini Ball Valve Dovetail - Thread

Kod Code	Ebat Size	Adet In Package
253	Ø 16x1/2	100
232	Ø 20x1/2	
233	Ø 20x3/4	

# DAMLA SULAMA EKİPMANLARI / DRIP IRRIGATION ACCESSORIES



Küresel Yassı Vidalı Boru Vanası

Mini Ball Valve Flat - Exit

Kod Code	Ebat Size	Açıklama Description	Adet In Package
256	Ø 17x17		100
254	Ø 16x17	Exit Nipple	
260	Ø 16x17	Barbed	
258	Ø 17x1/2		
731	Ø 19x22		
732	Ø 22x1/2		
733	Ø 22x3/4		



Küresel Yassı Vidalı Boru Vanası

Mini Ball Valve Connector Ring - Exit

Kod Code	Ebat Size	Açıklama Description	Adet In Package
257	Ø 17x17		100
255	Ø 16x17	Exit Nipple	
250	Ø 16x17	Barbed	
259	Ø 17x1/2		
736	Ø 19x22		
737	Ø 22x1/2		
738	Ø 22x3/4		



Küresel Çiftli Mini Vana

Double Mini Ball Valve Dovetail - Exit

Kod Code	Ebat Size	Adet In Package
261	Ø 16x16x16	50
274	Ø 16x19x16	
263	Ø 16x1/2x16	
275	Ø 16x3/4x16	
266	Ø 20x20x20	
262	Ø 20x1/2x20	
273	Ø 20x3/4x20	



Küresel Çiftli Mini Vana Yüzüklü

Double Mini Ball Valve Connector Ring - Dovetail

Kod Code	Ebat Size	Adet In Package
265	Ø 17x16x17	50
269	Ø 17x20x17	
264	Ø 17x1/2x17	
270	Ø 17x3/4x17	



Küresel Çiftli Mini Vana Vidalı

Double Mini Ball Valve Flat - Exit

Kod Code	Ebat Size	Adet In Package
268	Ø 17x16x17	50
272	Ø 17x19x17	
267	Ø 17x1/2x17	
271	Ø 17x3/4x17	



TE Vana Yassı Yüzüklü

Mini Ball Valve Tee Connector Ring - Exit

Kod Code	Ebat Size	Adet In Package
727	Ø 17x16x17	50
723	Ø 17x19x17	
721	Ø 22x19x22	
722	Ø 17x1/2x17	
720	Ø 22x1/2x22	



Lay Flat Boru Çıkış Parçası

Lay Flat Offtake

Kod Code	Ebat Size	Adet In Package
353	1/2"	250

# DAMLA SULAMA EKİPMANLARI / DRIP IRRIGATION ACCESSORIES



TE Vana Vidalı/ Mini Ball Valve Tee Flat - Exit

Kod Code	Ebat Size	Adet In Package
724	Ø 17x16x17	50
725	Ø 17x19x17	
728	Ø 22x19x22	
726	Ø 17x1/2x17	
729	Ø 22x1/2x22	



Çoklu Dağıtıcı 1" Ø17/ Dripline Multicoupling

Kod Code	Açıklama Description	Adet In Package
399	2'li	50
398	3'lü	
397	4'lü	
396	6'lı	



Yüzlükü Yassı Boru Çıkış Parçası/ Lay Flat Offtake

Kod Code	Ebat Size	Adet In Package
305	Ø 17	250



Yassı Vidalı Çıkış Adaptörü/ Tape Offtake

Kod Code	Ebat Size	Adet In Package
306	Ø 17x1/2	250



Yüzlükü Yassı Boru Ekeme Manşon/ Connector Ring

Kod Code	Ebat Size	Adet In Package
393	Ø 17x17	250
710	Ø 22x22	100



Yassı Vidalı Ekeme Manşon/ Tape Coupling

Kod Code	Ebat Size	Adet In Package
390	Ø 17x17	250
714	Ø 22x22	100



Yüzlükü Yassı Boru Çıkış Adaptörü/ Connector Ring - Exit

Kod Code	Ebat Size	Adet In Package
394	Ø 17	250
711	Ø 22x19	100



Yassı Vidalı Çıkış Adaptörü/ Tape Offtake

Kod Code	Ebat Size	Adet In Package
391	Ø 16x17	250
715	Ø 22x19	100



Yüzlükü Yassı Kör Tapa/ End Plug - Ring

Kod Code	Ebat Size	Adet In Package
716	Ø 17	250
712	Ø 22	100



Yassı Vidalı Kör Tapa/ End Plug - Flat

Kod Code	Ebat Size	Adet In Package
392	Ø 17	250
713	Ø 22	100

# DAMLA SULAMA EKİPMANLARI / DRIP IRRIGATION ACCESSORIES



Grommet Conta Konik

Grommet Ring

Kod Code	Ebat Size	Adet In Package
370	Ø 16	500
514	Ø 20	250



Grommet Conta Düz

Grommet Ring - Plain

Kod Code	Ebat Size	Adet In Package
510	Ø 16	500
511	Ø 20	



Kanallı Conta

Grommet Ring - Grooved

Kod Code	Ebat Size	Adet In Package
512	Ø 16	500
513	Ø 20	



Grommet Conta Kör

Grommet Ring Stopper

Kod Code	Ebat Size	Adet In Package
371	Ø 16	500
515	Ø 20	



Yassı Boru Vidalı TE

Tape Coupling Tee

Kod Code	Ebat Size	Adet In Package
395	Ø 17x17x17	100



Boru Delme Aparatı

Drilling Tools

Kod Code	Ebat Size	Adet In Package
411	16 mm	50
413	20 mm	

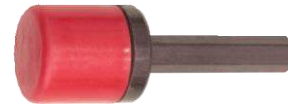

Matkap Ucu Boru Delme Aparatı

Drilling Tools - Drip Type

Kod Code	Ebat Size	Adet In Package
412	16 mm	50
414	20 mm	



Damla Delme Aparatı

Punch

Kod Code	Ebat Size	Adet In Package
410	3 mm	50



Debi Ayarlı Hat Üstü Damlatıcı

Regulated Dripper - Red

Kod Code	Açıklama Description	Adet In Package
368	0-70 lt/h	1000
369	0-100 lt/h	500
801	0-150 lt/h	250



Basınç Ayarlı Hat Üstü Damlatıcı

Pressure Compensating (PC) Dripper

Kod Code	Açıklama Description	Adet In Package
500	Blue: 2lt./h	500
	Red: 4lt./h	
	Yellow: 8lt./h	
	Purple: 12lt./h	
	Brown: 16lt./h	



Sabit Debi Hat Üstü Damlatıcı (Katif)

Fixed Flow Dripper

Kod Code	Açıklama Description	Adet In Package
501	Green: 2 lt./h	1000
	Red: 4lt./h	
	Yellow: 8lt./h	
802	Purple: End Cap 7 mm	1000



40lt. 80lt. 120lt. 160lt. 200lt.

Seraların MiniSprink

For Greenhouses Mini Sprinkler - Misting

Kod Code	Açıklama Description	Adet In Package
53	-	100



40lt. 80lt. 120lt. 160lt. 200lt.

Seraların Mini Sprink Takımı

For Greenhouses Mini Sprinkler Full Set

Kod Code	Açıklama Description	Adet In Package
52	-	100



Misting (Sisleme)

Misting

Kod Code	Açıklama Description	Adet In Package
409	3 lt/h	100



Misting Sisleme Takımı

Misting Full Set

Kod Code	Açıklama Description	Adet In Package
33	2 Head set:6 lt/h	100
34	4 Head set:12 lt/h	



MiniSprink

Rotating Sprayer

Kod Code	Açıklama Description	Adet In Package
402	Green: 80 lt.	100
	Red: 120 lt.	
	Yellow: 160 lt.	



Kazıklı Mini Sprink Seti			
Rotating Sprayer Set			
Kod Code	Açıklama Description	Adet In Package	
400	Green: 80 lt.	100	
	Red: 120 lt.		
	Yellow: 160 lt.		
403	40 cm. Mini Sprinkler Stake		



Uzun Sprink Kazığı			
Mini Sprinkler Stake			
Kod Code	Açıklama Description	Adet In Package	
803	80 cm Long Sprinkler Stake	500	



Sabit Açılı Super Mini Sprink Set			
Radius Stable Sprayer Set			
Kod Code	Açıklama Description	Adet In Package	
406	Green: 90° 120 lt./h	500	
	Red: 180° 120 lt./h		
	Yellow: 360° 120 lt./h		
408	Super Mini Sprinkler with Fixe Angle		



Saksı Sulama Kazığı Set			
Hydroponic Stake Set			
Kod Code	Ebat Size	Adet In Package	
401	Pipe Long: 50 cm 4lt	100	

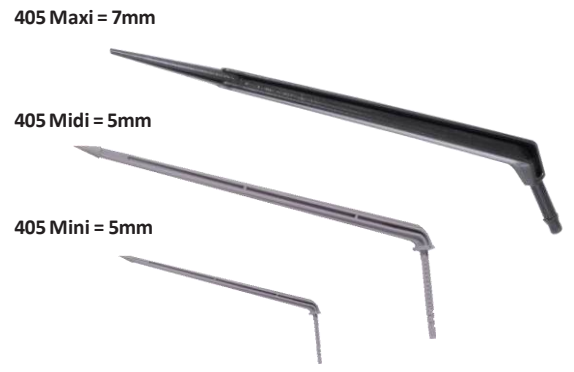

Saksı Sulama Kazığı			
Hydroponic Stake			
Kod Code	Ebat Size	Adet In Package	
405	5 mm	500	
	7 mm		



Pvc Spagetti Boru (100 mt)			
Spaghetti Pipe			
Kod Code	Ebat Size	Adet In Package	
407	7 - 5 mm	-	

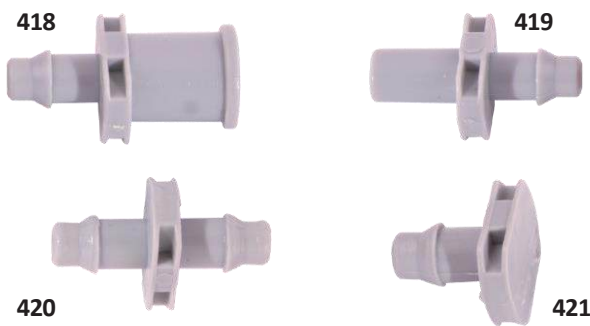

7mm Nozul Adaptör			
Nipple Adaptor			
Kod Code	Açıklama Description	Adet In Package	
418	Female Adaptor	500	
419	Male Adaptor		
420	Adaptor		
421	End Cap		

7mm Nozul Adaptör			
Nipple Adaptor			
Kod Code	Açıklama Description	Adet In Package	
418	Female Adaptor	500	
419	Male Adaptor		
420	Adaptor		
421	End Cap		

# DAMLA SULAMA EKİPMANLARI / DRIP IRRIGATION ACCESSORIES

223



224



5mm Vidalı Start Çıkış

Start Adaptor

Kod Code	Açıklama Description	Adet In Package
223	One side	500
224	Double side	



TE (Spagetti Boru için)

Spaghetti Pipe Connector Tee

Kod Code	Ebat Size	Adet In Package
422	7 mm	100



5mm Dağıtıcı

Manifold

Kod Code	Açıklama Description	Adet In Package
425	2'li	100
426	4'lü	



Fotoselli Yabani Hayvan Kağına Lampa 3 Renk

Photocell Lamp 3 Color

Kod Code	Açıklama Description	Adet In Package
61	Light colour: White, Red, Green	50



Damlama Çıkış Nipeli

Barbed Starter

Kod Code	Ebat Size	Adet In Package
375	Ø 16	500
520	Ø 20	
550	Ø 19x3/4 (Mil adaptor)	



Damlama Ekme Nipeli

Barbed Nipple

Kod Code	Ebat Size	Adet In Package
372	Ø 16x16	500
374	Ø 20x20	
373	Ø 16x20 (Reduced)	



Damlama Nipel Dirsek

Elbow Barbed Connector

Kod Code	Ebat Size	Adet In Package
378	Ø 16x16	500
379	Ø 20x20	



TENipel

Connector Tee Nipple

Kod Code	Ebat Size	Adet In Package
380	Ø 16x16x16	250
381	Ø 20x20x20	
530	Ø 16x20x16	
382	Ø 20x16x20	

# DAMLA SULAMA EKİPMANLARI / DRIP IRRIGATION ACCESSORIES



TENipel

Dovetail Tee - Thread

Kod Code	Ebat Size	Adet In Package	
546	Ø 16x1/2x16	250	
547	Ø 16x3/4x16		
548	Ø 20x1/2x20		
549	Ø 20x3/4x20		



PipoDirsek

Barbed Male Elbow

Kod Code	Ebat Size	Adet In Package	
388	Ø 16x1/2	250	
389	Ø 16x3/4		
540	Ø 20x1/2		
541	Ø 20x3/4		



ErkekAdaptör

Male Adaptor

Kod Code	Ebat Size	Adet In Package	
542	Ø 16x1/2	250	
543	Ø 16x3/4		
544	Ø 20x1/2		
545	Ø 20x3/4		



Boru Sabitleme Kazığı

Pipe Stabilizer

Kod Code	Ebat Size	Adet In Package	
383	Ø 16x20 17 cm.	250	
502	Ø 16x20 25 cm.	100	



PEKelepçe

Offtake Clamp

Kod Code	Ebat Size	Adet In Package	
386	Ø 16	1000	
387	Ø 20	500	



Özel Boru Asma Çengeli

Pipe Hanging Hook

Kod Code	Ebat Size	Adet In Package	
404	Ø 16 / Ø 20	500	



Gözlük Kör Tapa

Line End Rings

Kod Code	Ebat Size	Adet In Package	
384	Ø 16	500	
385	Ø 20		



Damlama Kör Tapa

Barbed End Cap

Kod Code	Ebat Size	Adet In Package	
376	Ø 16	500	
377	Ø 20		



Manşon			
Coupling Inside Thread			
Kod Code	Ebat Size	Adet In Package	
551	Ø 1/2x1/2	100	
552	Ø 3/4x3/4		
5408	1"		



Damla Dışı Kır Tapa			
Barbed End Cap			
Kod Code	Ebat Size	Adet In Package	
610	Ø 1/2	100	
611	Ø 3/4		
612	Ø 1"		



Redüksiyon			
Reducing Thread - Male Female / Female Female			
Kod Code	Ebat Size	Açıklama Description	Adet In Package
5411	1/2" x 1"	Female-Male	100
5410	3/4" x 1"	Female-Male	
5409	1" x 3/4"	Female-Female	



Sprey Başlıklı Pop- Uplar			
Pop-Up Spray Sprinkler			
Kod Code	Açıklama Description	Adet In Package	
3414	Entry size 1/2" Flow Radius 3-6 m distance	100	



Nipel			
Nipple Thread			
Kod Code	Ebat Size	Adet In Package	
5427	1/2" x 1/2"	100	
5413	3/4" x 3/4"		
5412	1"		
5419	1/2" x 3/4"		



Can Suyu Musluğu ve Anahtarı			
Quick Coupling Valve and Key			
Kod Code	Açıklama Description	Adet In Package	
6405	Quik Coupling 3/4" or 1" Key	100	



Damla Erkek Kır Tapa			
Barbed End Cap			
Kod Code	Ebat Size	Adet In Package	
600	Ø 1/2	100	
601	Ø 3/4		
602	Ø 1		



Can Suyu Musluğu ve Anahtarı			
Extension Pipe			
Kod Code	Ebat Size	Adet In Package	
5414	25 cm	-	
	35 cm		
	50 cm		
	100 cm		

# DAMLA SULAMA EKİPMANLARI / DRIP IRRIGATION ACCESSORIES

## Product Name

Mini Valve Barbed

Product Code	Features	Box Quantity
DTK3053A	32x32	110



If the rotary claw is broken, it makes a wide shot Consumption.



If the rotary claw is broken, it makes a wide shot Consumption.

## Product Name

Under Tree Mini Sprink Top Hook

Product Code	Color	Consumption	Soaking Diameter: Clawed	Soaking Diameter: No Nail	Bar	Package
DT4001	Brown	27 Lt/h	1.3 Mt.	4.5 Mt.	2.5	50
DT4002	Black	70 Lt/h	1.3 Mt.	5.5 Mt.	2.5	50
DT4003	Orange	90 Lt/h	1.3 Mt.	6.0 Mt.	2.5	50
DT4004	Red	120 Lt/h	1.3 Mt.	6.5 Mt.	2.5	50
DT4005	Blue	150 Lt/h	1.3 Mt.	7.0 Mt.	2.5	50



## Product Name

Under Tree Mini Sprinkler White Nailless Rotary Head

Product Code	Color	Consumption	Soaking Diameter	Bar	Package
DT4009	Yellow	200 Lt/h	9.0 Mt.	2.5	50
DT4010	Pink	250 Lt/h	10.0 Mt.	2.5	50
DT4011	Green	300 Lt/h	10.0 Mt.	2.5	50



## Product Name

Under Tree Mini Sprinkler Blue Spiked Rotary Head

Product Code	Color	Consumption	Soaking Diameter: Clawed	Soaking Diameter: No Nail	Bar	Package
DT4006	Yellow	200 Lt/h	2.5 Mt.	8.0 Mt.	2.5	50
DT4007	Pink	250 Lt/h	3.5 Mt.	8.5 Mt.	2.5	50
DT4008	Green	300 Lt/h	3.5 Mt.	8.5 Mt.	2.5	50



## Product Name

Mini Sprinkler Fogging Head

Product Code	Color	Consumption	Bar	Package
DT4060	Brown	23 Lt/h	2.5	100
DT4061	Orange	40 Lt/h	2.5	100



## Product Name

Microjet

Product Code	Color	Consumption	Soaking Diameter: Clawed	Soaking Diameter: No Nail	Bar	Package
DT4529A	Red	300 Lt/h	3 Mt.	12,5 Mt.	2	100

## Product Name

Leaf Sprink Headline

Product Code	Color	Consumption	Soaking Diameter	Bar	Box Quantity
DT4080	Black	600 Lt/h	14.0 Mt.	2.5	400



Product Name					
Turbo Flood Mini Sprinkler Head					
Product Code	Color	Consumption	Soaking Diameter	Bar	Package
DT4020	Black	70 Lt/h	7.5 Mt.	2.5	100
DT4021	Green	90 Lt/h	7.5 Mt.	2.5	100
DT4022	Blue	105Lt/h	8.5 Mt.	2.5	100
DT4023	Red	120Lt/h	10.0 Mt.	2.5	100
DT4024	Brown	160Lt/h	10.5 Mt.	2.5	100
DT4025	Yellow	200Lt/h	11.0 Mt.	2.5	100
DT4026	White	250Lt/h	11.0 Mt.	2.5	100
DT4027	Dark Green	300Lt/h	11.5 Mt.	2.5	100

Product Name					
Mini Sprinkler Normal Rotary Head					
Product Code	Color	Consumption	Soaking Diameter	Bar	Package
DT4030	Black	70 Lt/h	7.0 Mt.	2.5	100
DT4031	Green	90Lt/h	7.5 Mt.	2.5	100
DT4032	Blue	105Lt/h	8.0 Mt.	2.5	100
DT4033	Red	120Lt/h	8.0 Mt.	2.5	100
DT4034	Brown	160Lt/h	8.5 Mt.	2.5	100
DT4035	Yellow	200Lt/h	9.0 Mt.	2.5	100
DT4036	White	250Lt/h	9.0 Mt.	2.5	100
DT3037	Dark Green	300Lt/h	9.5 Mt.	2.5	100



- \* Mini Sprinkler Head
- \* 7 mm Start Out
- \* 1 mt 7 mm spaghetti Nozzle Hose
- \* 40 cm Clip-on Stake

Product Name					
Mini Sprink Round Rotary Head					
Product Code	Color	Consumption	Soaking Diameter	Bar	Package
DT4040	Orange	40Lt/h	4.0 Mt.	2.5	100
DT4041	Black	70Lt/h	6.0 Mt.	2.5	100
DT4042	Green	90Lt/h	6.0 Mt.	2.5	100
DT4043	Blue	105Lt/h	6.0 Mt.	2.5	100
DT4044	Red	120Lt/h	6.5 Mt.	2.5	100
DT4045	Brown	160Lt/h	6.5 Mt.	2.5	100
DT4046	Yellow	200Lt/h	7.0 Mt.	2.5	100
DT4047	White	250Lt/h	7.0 Mt.	2.5	100
DT4048	Dark Green	300Lt/h	7.0 Mt.	2.5	100
DT4049	Pink	400Lt/h	8.0 Mt.	2.5	100

Product Name					
Mini Sprinkler Normal Rotary Set					
Product Code	Color	Consumption	Soaking Diameter	Bar	Team Box Name.
DT4520	Orange	40Lt/h	4.0 Mt.	2.5	100
DT4521	Black	70Lt/h	6.0 Mt.	2.5	100
DT4522	Green	90Lt/h	6.0 Mt.	2.5	100
DT4523	Blue	105Lt/h	6.0 Mt.	2.5	100
DT4524	Red	120Lt/h	6.5 Mt.	2.5	100
DT4525	Brown	160Lt/h	6.5 Mt.	2.5	100
DT4526	Yellow	200Lt/h	7.0 Mt.	2.5	100
DT4527	White	250Lt/h	7.0 Mt.	2.5	100
DT4528	Dark Green	300Lt/h	7.0 Mt.	2.5	100
DT4529	Pink	400Lt/h	8.0 Mt.	2.5	100

# DAMLA SULAMA EKİPMANLARI / DRIP IRRIGATION ACCESSORIES



If the rotary claw is broken, it makes a wide shot Consumption.

**Product Name**  
Turbo Mini Sprink Normal Rotary Head

**Product Name**  
Turbo Jet Sprink  
Ragged Rotary Head Grooved 3/8"

Product Code	Color	Consumption	Soaking Diameter	Bar	Package
DT4070	Black	70Lt/h	7.0 Mt.	2.5	50
DT4071	Green	90Lt/h	7.5 Mt.	2.5	50
DT4072	Blue	105Lt/h	8.0 Mt.	2.5	50
DT4073	Red	120Lt/h	8.0 Mt.	2.5	50
DT4074	Brown	160Lt/h	8.5 Mt.	2.5	50
DT4075	Yellow	200Lt/h	9.0 Mt.	2.5	50
DT4076	White	250Lt/h	9.0 Mt.	2.5	50
DT4077	Dark Green	300Lt/h	9.5 Mt.	2.5	50

Product Code	Color	Consumption	Soaking Diameter	Bar	Package
DT4080	Yellow	200Lt/h	10.5 Mt.	2.5	100
DT4091	White	250Lt/h	11.0 Mt.	2.5	100
DT4082	Dark Green	300Lt/h	11.5 Mt.	2.5	100
DT4093	Pink	400Lt/h	12.0 Mt.	2.5	100
DT4084	Dark Purple	500Lt/h	12.5 Mt.	2.5	100



\* Turbo Flood Mini Sprink Head  
\* 7 mm Start Out  
\* 1 mt 7 mm spaghetti Nozzle Hose  
\* 50 cm Black Stake



\* Turbo Mini Sprinkler Head  
\* 7 mm Starting Output  
\* 1m 7 mm Spaghetti Nozzle Hose \*  
40 cm Clip-on Stake

**Product Name**  
Turbo Flood Mini Sprinkler Set

**Product Name**  
Turbo Mini Sprink Normal Rotary Set

Product Code	Color	Consumption	Soaking Diameter	Bar	Team Box Name.
DT4501	Black	70Lt/h	7.5 Mt.	2.5	100
DT4502	Green	90Lt/h	7.5 Mt.	2.5	100
DT4503	Blue	105Lt/h	8.5 Mt.	2.5	100
DT4504	Red	120Lt/h	10.0 Mt.	2.5	100
DT4505	Brown	160Lt/h	10.5 Mt.	2.5	100
DT4506	Yellow	200Lt/h	11.0 Mt.	2.5	100
DT4507	White	250Lt/h	11.0 Mt.	2.5	100
DT4508	Dark Green	300Lt/h	11.5 Mt.	2.5	100

Product Code	Color	Consumption	Soaking Diameter	Bar	Team Box Name.
DT4510	Black	70 Lt/h	7.0 Mt.	2.5	100
DT4511	Green	90Lt/h	7.5 Mt.	2.5	100
DT4512	Blue	105Lt/h	8.0 Mt.	2.5	100
DT4513	Red	120Lt/h	8.0 Mt.	2.5	100
DT4514	Brown	160Lt/h	8.5 Mt.	2.5	100
DT4515	Yellow	200Lt/h	9.0 Mt.	2.5	100
DT4516	White	250Lt/h	9.0 Mt.	2.5	100
DT4517	Dark Green	300Lt/h	9.5 Mt.	2.5	100

# AIR RELIEF VALVE



## Product Name

1" AIR RELIEF VALVE

Product Code	Features	Box Quantity
<b>DTK2010</b>	3/4" Air Suction Cup	80
<b>DTK2020</b>	1" Air Suction Cup	75



## Product Name

1" DOUBLE ACTION AIR RELIEF VALVE

Product Code	Features	Box Quantity
<b>DTK2030</b>	1" Double Acting	60



## Product Name

2" AIR RELIEF VALVE

Product Code	Features	Box Quantity
<b>DTK2040</b>	2" Air Suction Cup	15



## Product Name

1 " Double Air Suction Cup

Product Code	Features	Box Quantity
<b>DTK2050</b>	2" Air Suction Cup	50

# ROUND DRIP IRRIGATION PIPES

## 16 mm Round Drip Irrigation Pipes



CODE	DIAMETER (Ø)	THICKNESS (mm)	RANGE (cm)	LENGTH	FLOW
D218	16	0,9	20	400	2-4-8
D219	16	0,9	25	400	2-4-8
D220	16	0,9	33	400	2-4-8
D221	16	0,9	40	400	2-4-8
D222	16	0,9	50	400	2-4-8
D223	16	0,9	60	400	2-4-8
D224	16	0,9	70	400	2-4-8
D225	16	0,9	75	400	2-4-8
D226	16	0,9	80	400	2-4-8
D227	16	0,9	90	400	2-4-8
D228	16	0,9	100	400	2-4-8

## 16 mm Round Drip Irrigation Pipes



CODE	DIAMETER (Ø)	THICKNESS (mm)	RANGE (cm)	LENGTH	FLOW
D229	16	1,0	20	400	2-4-8
D230	16	1,0	25	400	2-4-8
D231	16	1,0	33	400	2-4-8
D232	16	1,0	40	400	2-4-8
D233	16	1,0	50	400	2-4-8
D234	16	1,0	60	400	2-4-8
D235	16	1,0	70	400	2-4-8
D236	16	1,0	75	400	2-4-8
D237	16	1,0	80	400	2-4-8
D238	16	1,0	90	400	2-4-8
D239	16	1,0	100	400	2-4-8

# ROUND DRIP IRRIGATION PIPES

## 20 mm Round Drip Irrigation Pipes



CODE	DIAMETER (Ø)	THICKNESS (mm)	RANGE (cm)	LENGTH	FLOW
D240	20	1,1	20	300	2-4-8
D241	20	1,1	25	300	2-4-8
D242	20	1,1	33	300	2-4-8
D243	20	1,1	40	300	2-4-8
D244	20	1,1	50	300	2-4-8
D245	20	1,1	60	300	2-4-8
D246	20	1,1	70	300	2-4-8
D247	20	1,1	75	300	2-4-8
D248	20	1,1	80	300	2-4-8
D249	20	1,1	90	300	2-4-8
D250	20	1,1	100	300	2-4-8

## Straight Drip Irrigation Pipes



CODE	DIAMETER (Ø)	THICKNESS (mm)	LENGTH
D251	16	0,9	400
D252	16	1,0	400
D331	16	1,1	400
D253	20	1,0	300
D254	20	1,2	300
D332	20	1,5	300
D255	25	1,2	200
D256	25	1,5	200
D333	25	2,0	200

# FLAT DRIP IRRIGATION PIPES



0,15 (mm) / Ø 17 (mm)

**6 mil**

CODE 1,6 Lt/H	CODE 2,2 Lt/H	DRIPPER DISTANCE (cm)	MT / ROLL
250-15001	250-15002	20	1800
250-15041	250-15042	25	2000
250-15003	250-15004	30	2000
250-15005	250-15006	40	2000
250-15007	250-15008	50	2000

0,20 (mm) / Ø 17 (mm)

**8 mil**

CODE 1,6 Lt/H	CODE 2,2 Lt/H	DRIPPER DISTANCE (cm)	MT / ROLL
250-15009	250-15010	20	2300
250-15044	250-15043	25	2300
250-15011	250-15012	30	2300
250-15013	250-15014	40	2300
250-15015	250-15016	50	2300

0,25 (mm) / Ø 17 (mm)

**10 mil**

CODE 1,6 Lt/H	CODE 2,2 Lt/H	DRIPPER DISTANCE (cm)	MT / ROLL
250-15017	250-15018	20	1700
250-15045	250-15046	25	1800
250-15019	250-15020	30	1800
250-15021	250-15022	40	1800
250-15023	250-15024	50	1800

0,30 (mm) / Ø 17 (mm)

**12 mil**

CODE 1,6 Lt/H	CODE 2,2 Lt/H	DRIPPER DISTANCE (cm)	MT / ROLL
250-15025	250-15026	20	1700
250-15047	250-15048	25	1800
250-15027	250-15028	30	1800
250-15029	250-15030	40	1800
250-15031	250-15032	50	1800

# FLAT DRIP IRRIGATION PIPES



0,40 (mm) / Ø 17 (mm)

**18 mil**

CODE	CODE	DRIPPER DISTANCE (cm)	MT / ROLL
1,6 Lt / H	2,2 Lt / H		
250-15033	250-15034	20	1300
250-15049	250-15050	25	1400
250-15035	250-15036	30	1400
250-15037	250-15038	40	1400
250-15039	250-15040	50	1400

0,20 (mm) / Ø 22 (mm)

**8 mil**

CODE	CODE	DRIPPER DISTANCE (cm)	MT / ROLL
1,6 Lt / H	2,2 Lt / H		
250-16001	250-16002	20	1700
250-16033	250-16034	25	1800
250-16003	250-16004	30	1800
250-16005	250-16006	40	1800
250-16007	250-16008	50	1800

0,25 (mm) / Ø 22 (mm)

**10 mil**

CODE	CODE	DRIPPER DISTANCE (cm)	MT / ROLL
1,6 Lt / H	2,2 Lt / H		
250-16009	250-16010	20	1300
250-16035	250-16036	25	1400
250-16011	250-16012	30	1400
250-16013	250-16014	40	1400
250-16015	250-16016	50	1400

0,30 (mm) / Ø 22 (mm)

**12 mil**

CODE	CODE	DRIPPER DISTANCE (cm)	MT / ROLL
1,6 Lt / H	2,2 Lt / H		
250-16017	250-16018	20	1000
250-16037	250-16038	25	1100
250-16019	250-16020	30	1100
250-16021	250-16022	40	1100
250-16023	250-16024	50	1100

0,40 (mm) / Ø 22 (mm)

**18 mil**

CODE	CODE	DRIPPER DISTANCE (cm)	MT / ROLL
1,6 Lt / H	2,2 Lt / H		
250-16025	250-16026	20	700
250-16039	250-16040	25	800
250-16027	250-16028	30	800
250-16029	250-16030	40	800
250-16031	250-16032	50	800

# LAY FLAT

## DATA SHEET

<b>DESCRIPTION</b>	LAY FLAT
<b>PRODUCT NAME</b>	MANYAS L
<b>MATERIAL</b>	POLYVINYLCHLORIDE



### Features

By combining mono layered polyester yarn and plastic material via using high technology, Manyas lay flat hoses are made of PVC-NBR material which is reinforced by resistant polyester yarn.

### Application

Suitable for use in drip irrigation systems and water transfer.

CODE	INCH (mm)	INSIDE DIA. (mm)	WORK PRESSURE (BAR)	BURST PRESSURE (BAR)	WEIGHT gr/mt	LENGTH (MT)
M.L.025.050 & M.L.025.100	1"	25	6	18	165	50/100
M.L.030.050 & M.L.030.100		30	6	18	190	50/100
M.L.032.050 & M.L.032.100	1.1/4"	32	6	18	200	50/100
M.L.038.050 & M.L.038.100	1.1/2"	38	6	18	210	50/100
M.L.040.050 & M.L.040.100		40	6	18	240	50/100
M.L.052.050 & M.L.052.100	2"	52	6	18	310	50/100
M.L.063.050 & M.L.063.100	2.1/2"	63	6	18	365	50/100
M.L.077.050 & M.L.077.100	3"	77	6	18	450	50/100
M.L.090.050 & M.L.090.100		90	6	18	560	50/100
M.L.102.050 & M.L.102.100	4"	102	6	18	650	50/100

-30 °C / +60 °C

STANDARD

COLOR

-22 °F / +140 °F

ISO 1307

DARK BLUE



## DATA SHEET

<b>DESCRIPTION</b>	LAY FLAT
<b>PRODUCT NAME</b>	MANYAS SL
<b>MATERIAL</b>	POLYVINYLCHLORIDE



### Features

By combining mono layered polyestern yarn and plastic material via using high technology, Manyas lay flat hoses are made of PVC-NBR material which is reinforced by resistant polyestern yarn.

### Application

Suitable for use in drip irrigation systems and water transfer.

CODE	INCH (mm)	INSIDE DIA. (mm)	WORK PRESSU RE (BAR)	BURST PRESSU RE (BAR)	WEIG HT gr/mt	LENG TH (MT )
M.SL.038.050 & M.SL.038.100	1 1/2"	38	3	9	185	50/10 0
M.SL.040.050 & M.SL.040.100		40	3	9	200	50/10 0
M.SL.052.050 & M.SL.052.100	2"	52	3	9	250	50/10 0
M.SL.060.050 & M.SL.060.100		60	3	9	280	50/10 0
M.SL.063.050 & M.SL.063.100	2 1/2"	63	3	9	300	50/10 0
M.SL.077.050 & M.SL.077.100	3"	77	3	9	380	50/10 0
M.SL.102.050 & M.SL.102.100	4"	102	3	9	450	50/10 0

-30 °C / +60 °C	STANDARD	COLOR
 -22 °F / +140 °F	ISO 1307	LIGHT BLUE

## DATA SHEET

<b>DESCRIPTION</b>	LAY FLAT
<b>PRODUCT NAME</b>	MANYAS M
<b>MATERIAL</b>	POLYVINYLCHLORIDE



### Features

By combining mono layered polyester yarn and plastic material via using high technology, Manyas lay flat hoses are made of PVC-NBR material which is reinforced by resistant polyester yarn.

### Application

Suitable for use in drip irrigation systems and water transfer.

CODE	INCH (mm)	INSID E DIA. (mm)	WOR K PRESSU RE (BAR)	BURS T PRESSU RE (BAR)	WEIG HT gr/mt	LENG TH (MT )
M.M.025.050 & M.M.025.100	1"	2 5	10	3 0	185	50/1 00
M.M.030.050 & M.M.030.100		3 0	10		210	50/1 00
M.M.032.050 & M.M.032.100	1 1/4	3 2	10	3 0	225	50/1 00
M.M.038.050 & M.M.038.100	1 1/2	3 8	10		270	50/1 00
M.M.040.050 & M.M.040.100		4 0	10	3 0	300	50/1 00
M.M.052.050 & M.M.052.100	2"	5 2	10		340	50/1 00
M.M.063.050 & M.M.063.100	2 1/2	6 3	10	3 0	420	50/1 00
M.M.077.050 & M.M.077.100	3"	7 7	10		670	50/1 00
M.M.090.050 & M.M.090.100		9 0	10	3 0	870	50/1 00
M.M.102.050 & M.M.102.100	4"	1 0 2	10	3 0	950	50/1 00

-30 °C / +60 °C

STANDARD

COLOR



-22 °F / +140 °F

ISO 1307

GREEN



**NEW**  
GENERATION

  
**datka**

📍 Mithatpaşa Cad. No: 45/1 Kızılay 06420 Çankaya  
Ankara / TÜRKİYE

☎ +90 312 385 50 31

📞 +90 505 587 35 54

🌐 [www.datka.com.tr](http://www.datka.com.tr)

✉ [datka@datkaltd.com](mailto:datka@datkaltd.com)



📘 /DatkaTurkey