

CATALOGUE FOR
AUTOMOTIVE
2022/001

PI100101-1

Ø20 INSERT

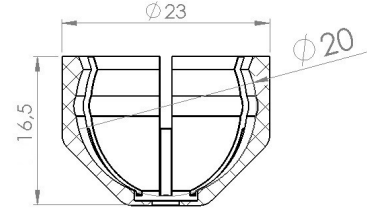
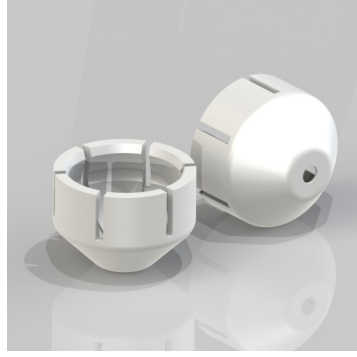
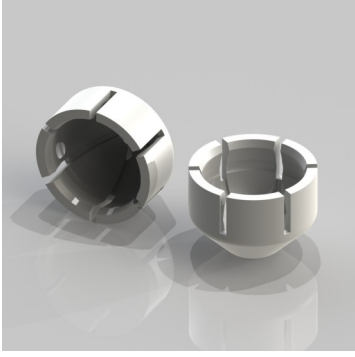

PI100201-2

Ø22 INSERT

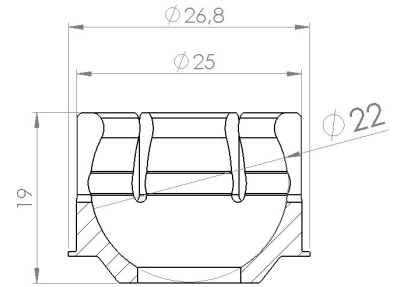
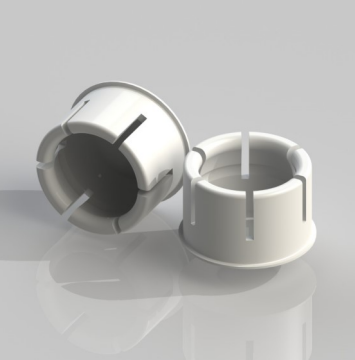

PI100201-1

Ø22 INSERT

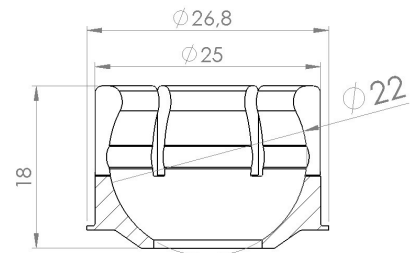
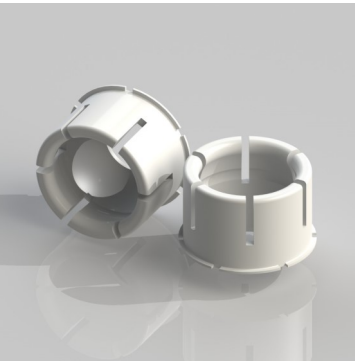

PI100301-1

Ø27 INSERT

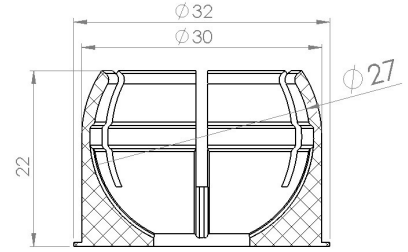
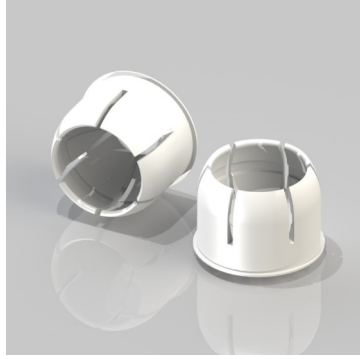

PI100401-1

Ø32 INSERT

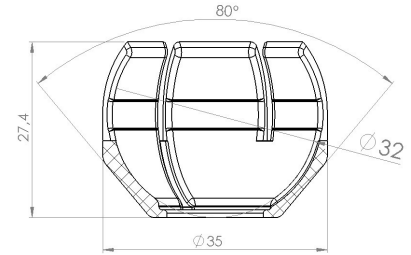
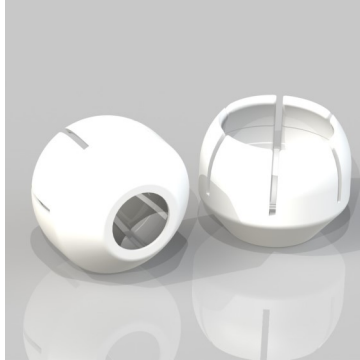
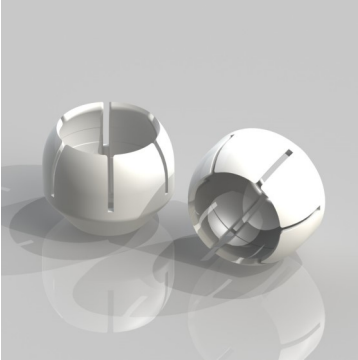

PI100501-1

Ø35 INSERT

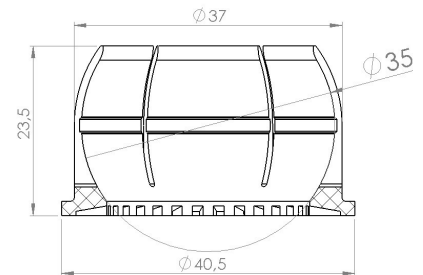

PI100601-1

Ø40 INSERT

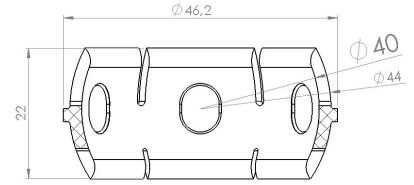
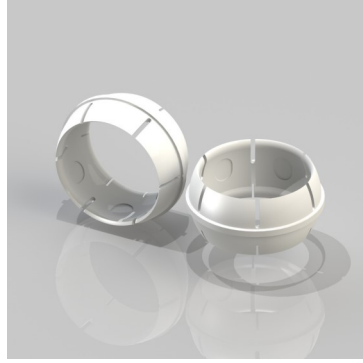
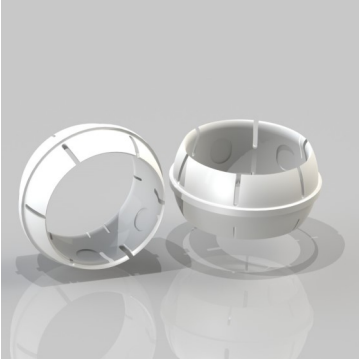

PI100701-1

Ø32 INSERT

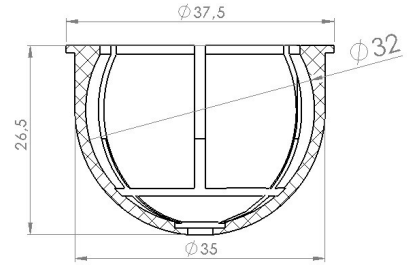
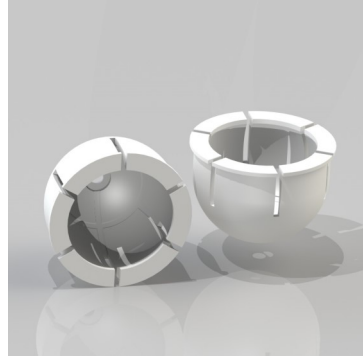
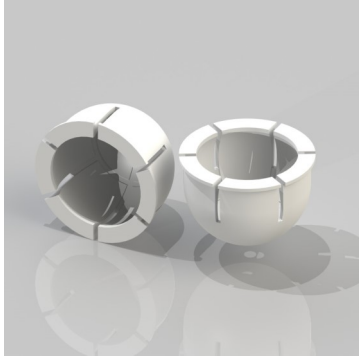

PI100801-1

Ø30 INSERT

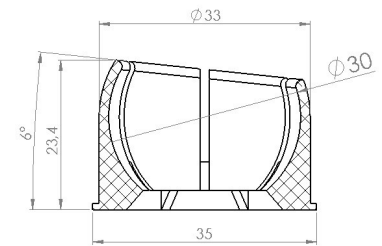
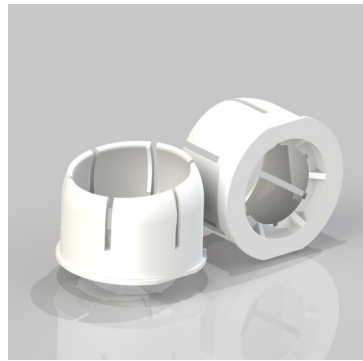
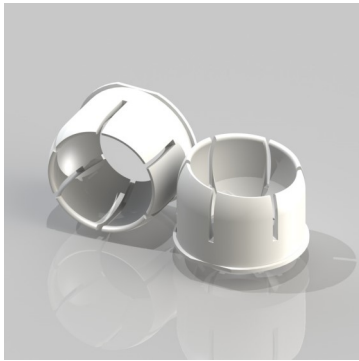

PI101001-1

Ø30 INSERT

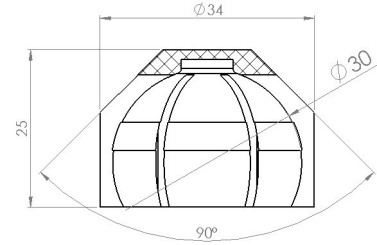
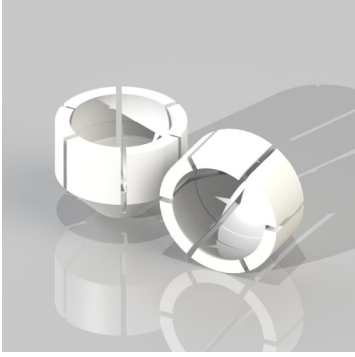

PI101101-1

Ø28 INSERT

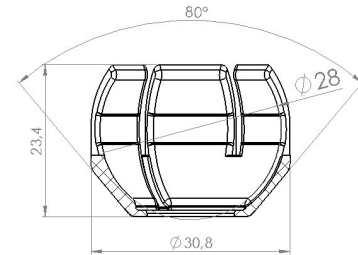
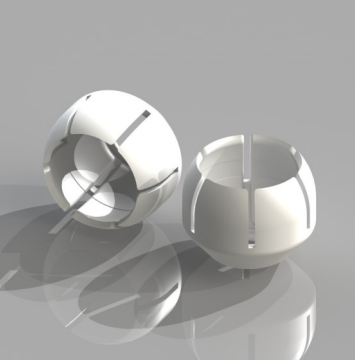

PI101201-2

Ø32 INSERT

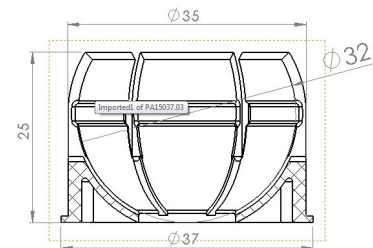
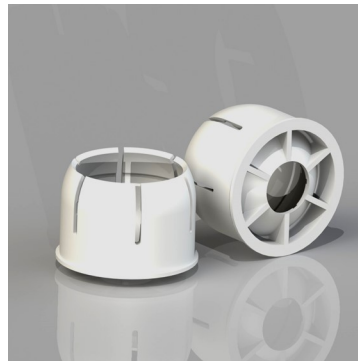
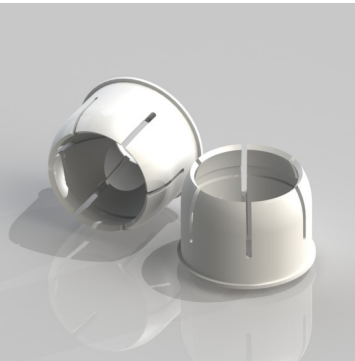

PI101301-1

Ø25 INSERT

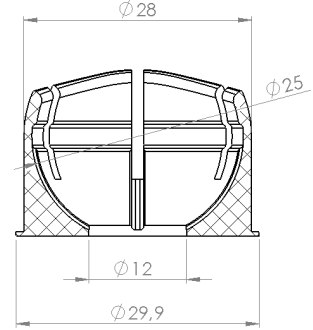
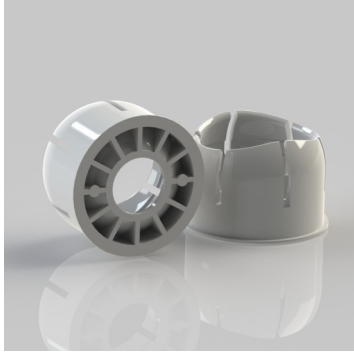

PI101401-1

Ø25 INSERT

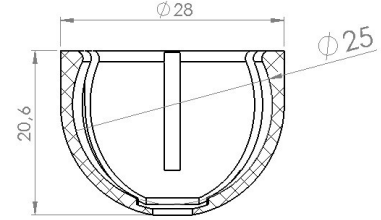
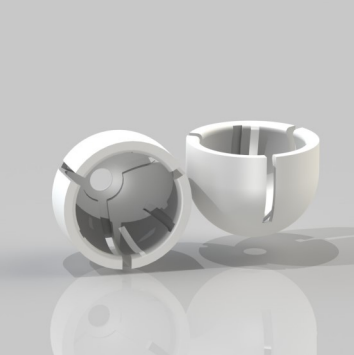

PI101501-2

Ø35 INSERT

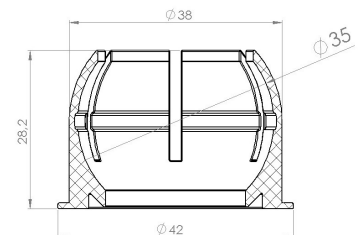
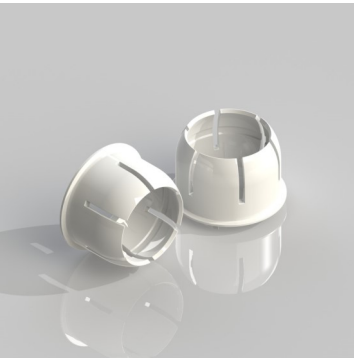

PI101604-1

Ø35 INSERT

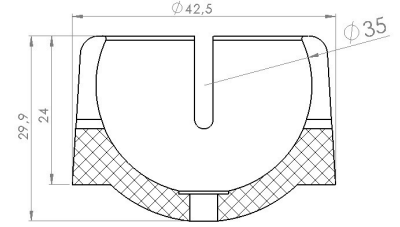
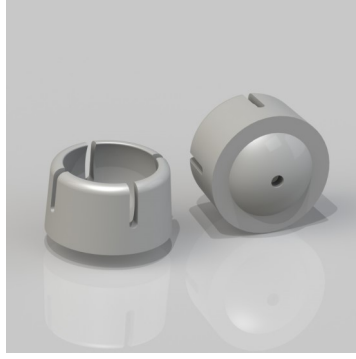
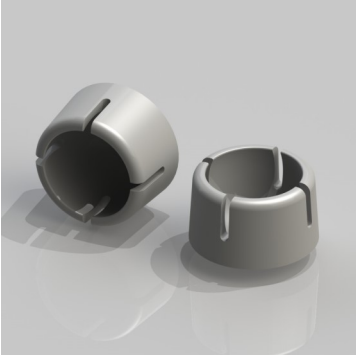

PI101701-1

Ø30 INSERT

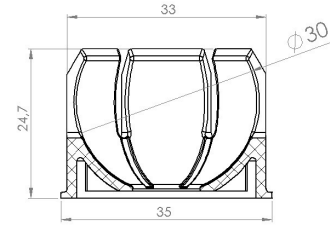
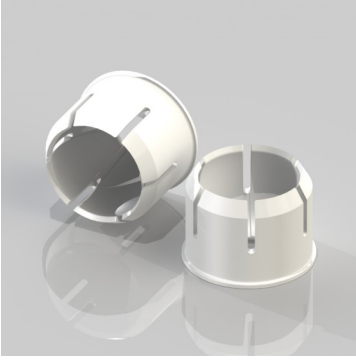

PI101801-1

INSERT

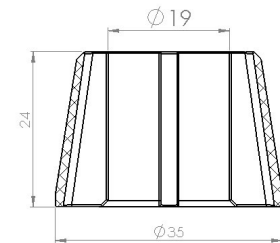
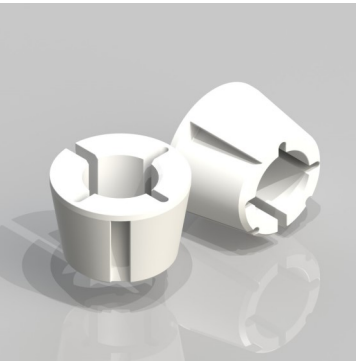

PI101901-1

Ø25 INSERT

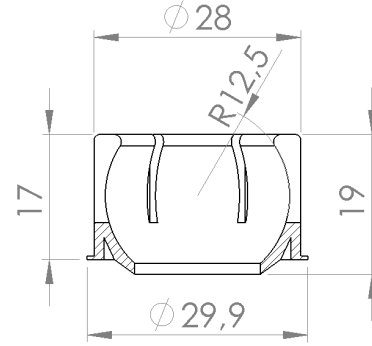
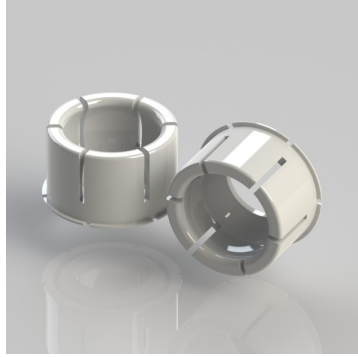
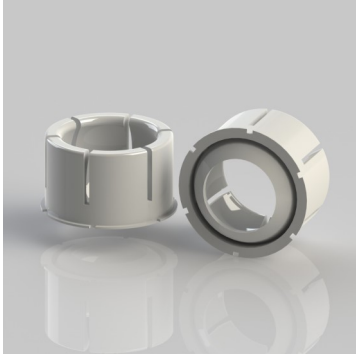

PI102004-1

Ø20 INSERT

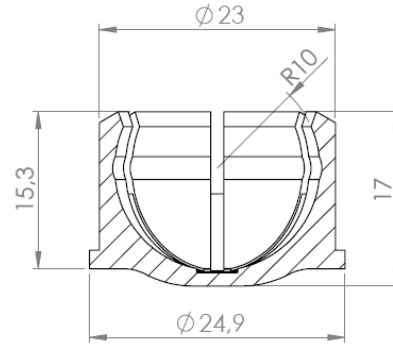
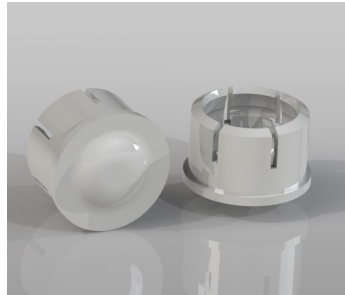
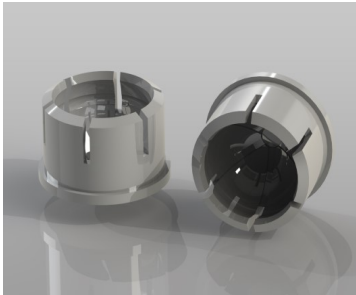

PI500113-1

PLASTIC

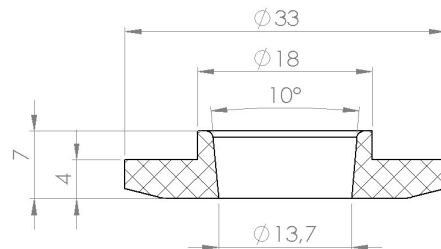
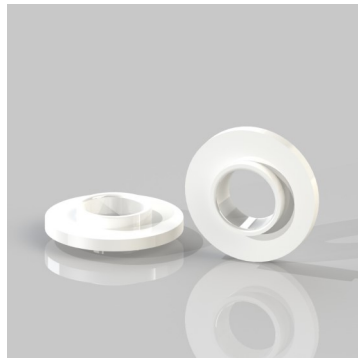

PJ900201-1

PLASTIC

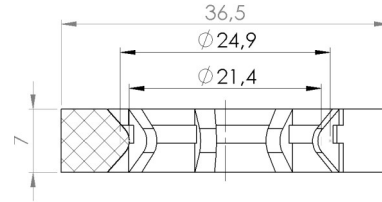
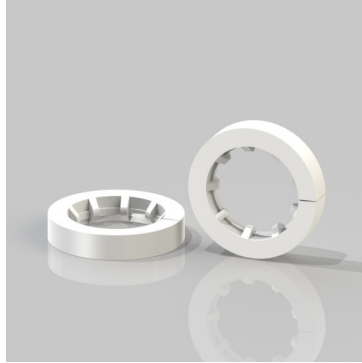
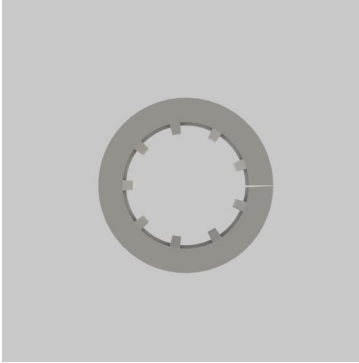

PJ900401-1

PLASTIC

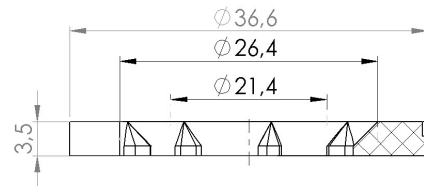

PJ900501-1

PLASTIC

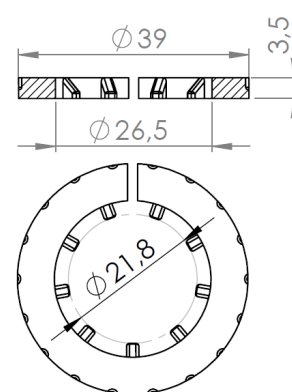

PI200101-1

DUST COVER

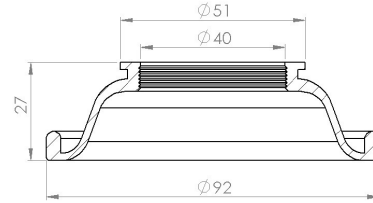
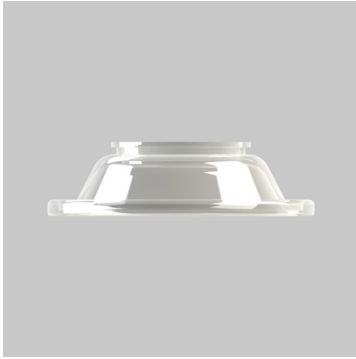

PI200201-1

DUST COVER

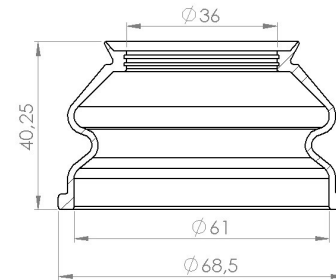
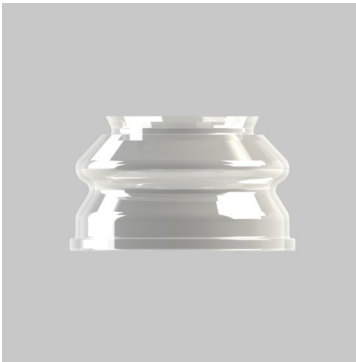

PI200301-1

DUST COVER

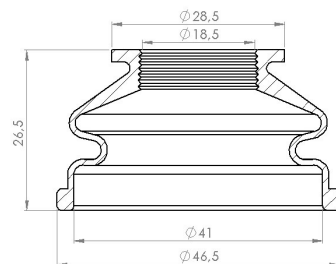
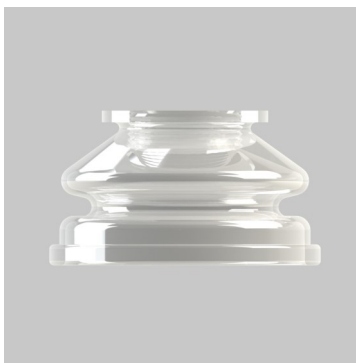

PI200401-1

DUST COVER

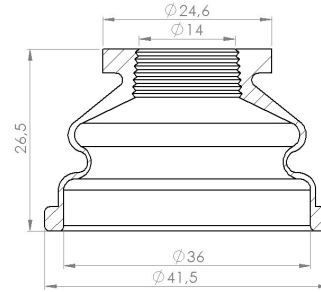

PI200501-1

DUST COVER

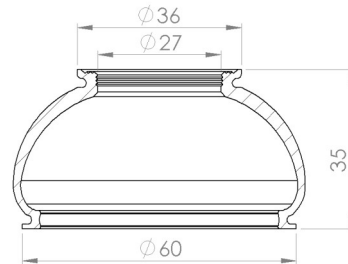

PI200601-1

DUST COVER

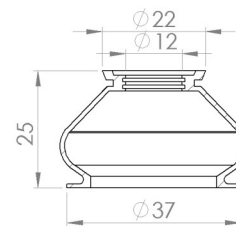
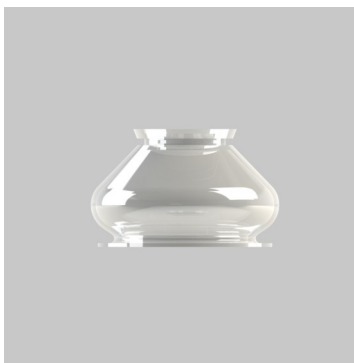

PI300103-1

COVER

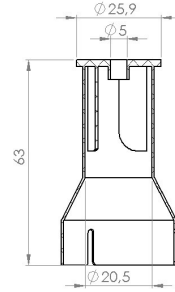
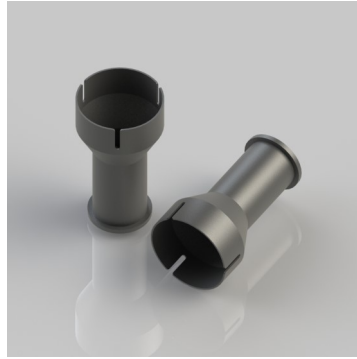

PI300203-1

COVER

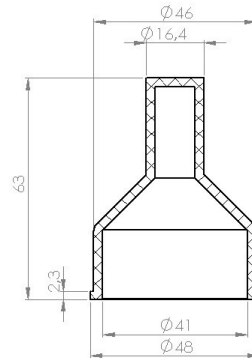

PI300303-1

COVER

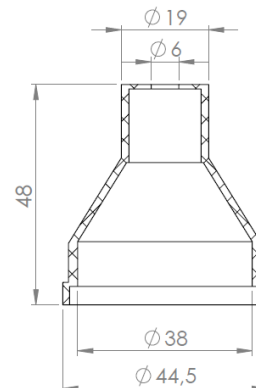
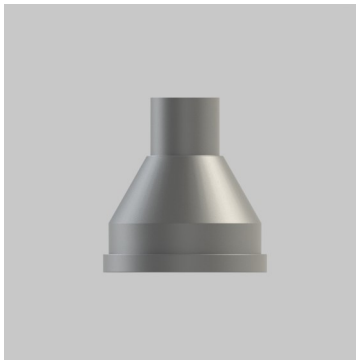

PI300403-1

COVER

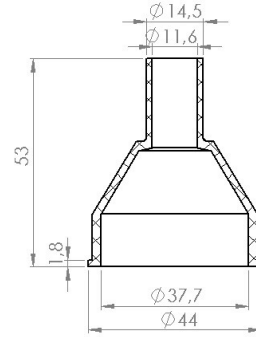

PI300503-1

COVER

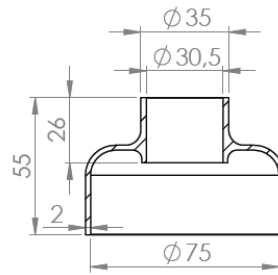
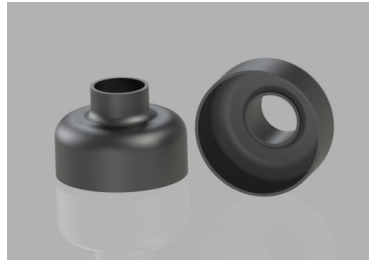

O-RING

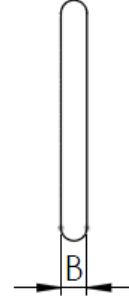
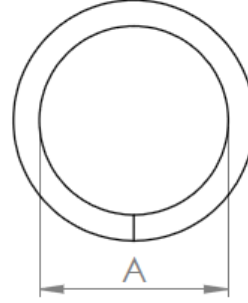

Product Code	Name of The Product	A	B
PI400101-1	Ø13xØ2,75mm O Ring (Natural)	13	2,75
PI400201-1	Ø13,5xØ2mm O Ring (Natural)	13,5	2
PI400301-1	Ø14xØ2mm O Ring (Natural)	14	2
PI400301-2	Ø14xØ2,25mm O Ring (Natural)	14	2,25
PI400301-3	Ø14xØ1,8mm O Ring (Natural)	14	1,8

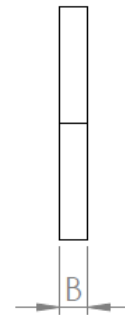
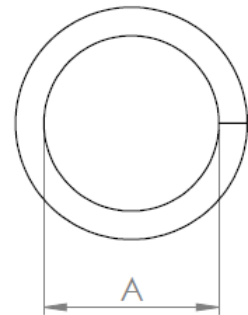

Product Code	Name of The Product	A	B
PI400401-2	Ø14x2,1mm O Ring (Natural)	14	2,1
PI400501-2	Ø14,5x2,1mm O Ring (Natural)	14,5	2,1
PI400601-2	Ø15x2,1mm O Ring (Natural)	15	2,1

PLASTIC RING

Farklı ölçü ve renkler için irtibata geçiniz.

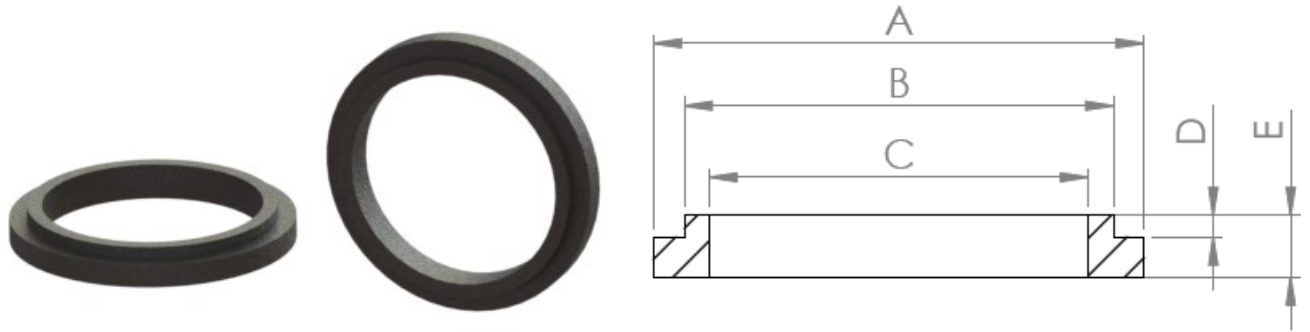

Product Code	Name of The Product	A	B	C	D	E
PI500303-1	Ø29,3 Plastic Ring	29,3	25,6	22,6	1,3	3,7
PI500403-1	Ø30,5 Plastic Ring	30,5	27,3	24	1,3	3,5

PLASTIC RING

Farklı ölçü ve renkler için irtibata geçiniz.

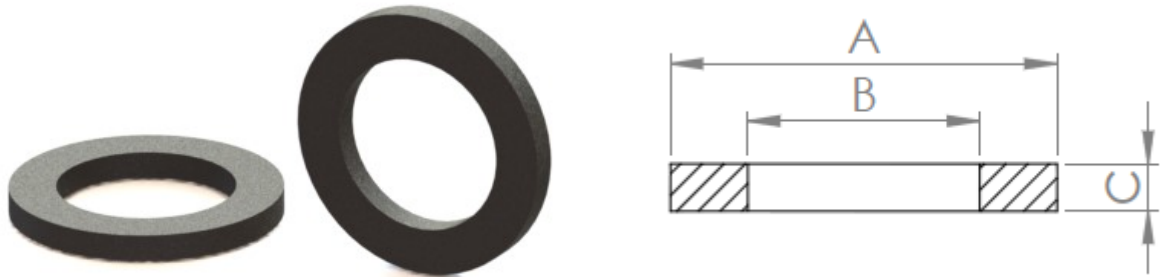

Product Code	Name of The Product	A	B	C
PI500203-1	Ø26 Plastic Ring	26	21,3	2,4
PJ1000103-1	Plastic Ring	40	26,2	4
PJ1000503-1	Plastic Ring	30	12,5	3

PJ1300101-1

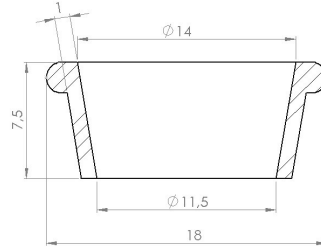

PJ1300201-1

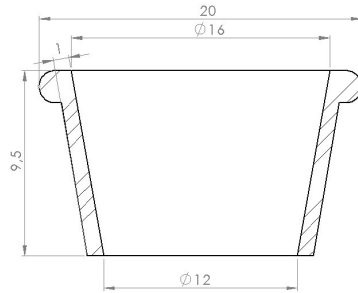

PJ1300301-1

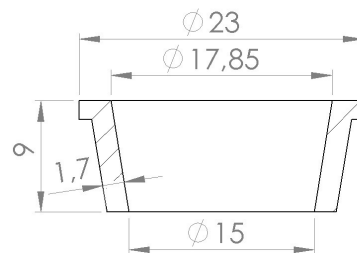

PJ1300401-1

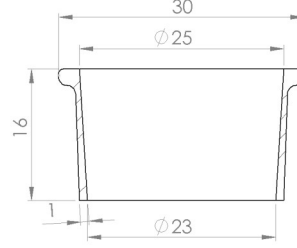
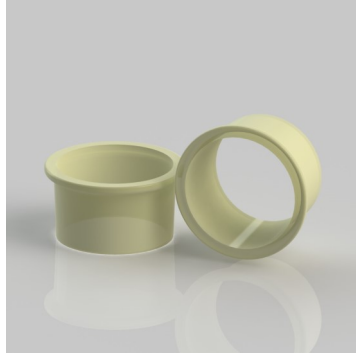

MP100103

METAL

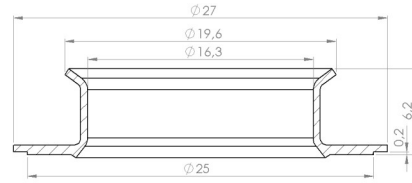
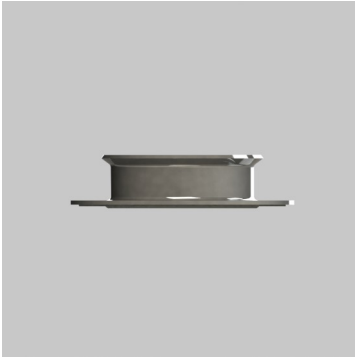

MP100203

METAL

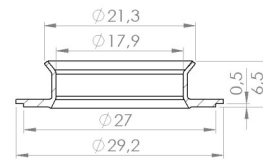

MP100303

METAL

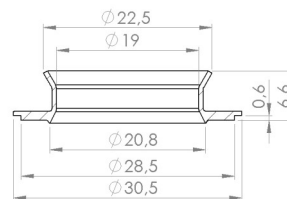

MP100403

METAL

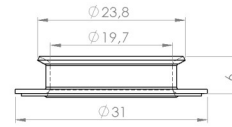

MP100403-1

METAL

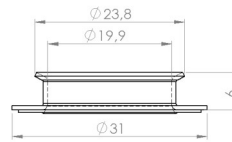

MP100503

METAL

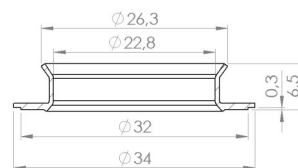

MP100601

METAL RING-STAINLESS

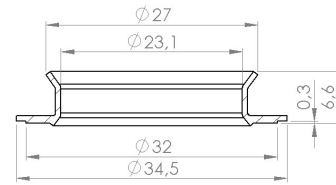
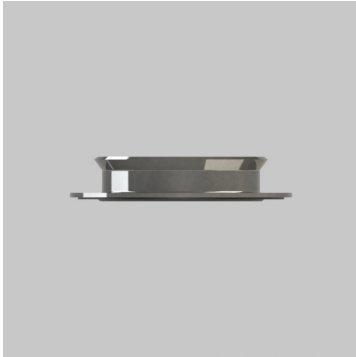

MP100703

METAL

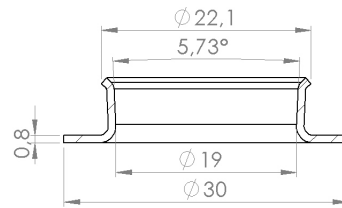

MP100803

METAL

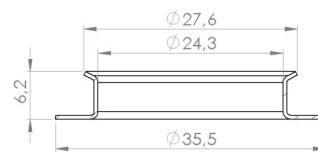

MP100903

METAL

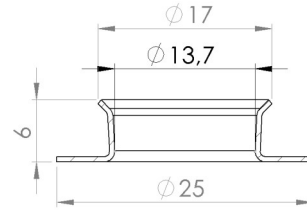

MP200103

CONICAL

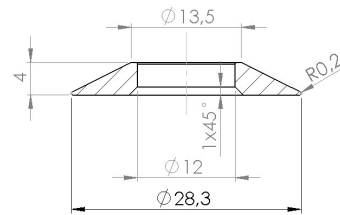
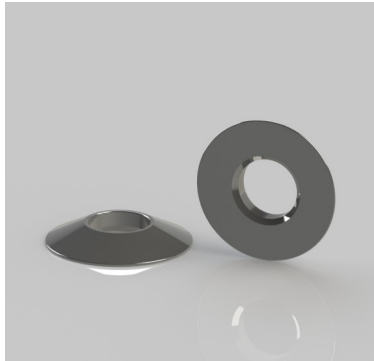
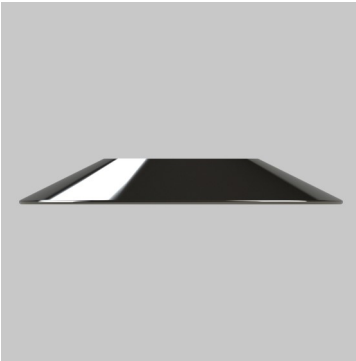

Various Products for Automotive

